

SQUELCH TALES

SAN DIEGO REPEATER ASSOCIATION

VOLUME VII

MARCH 1979

NUMBER 3

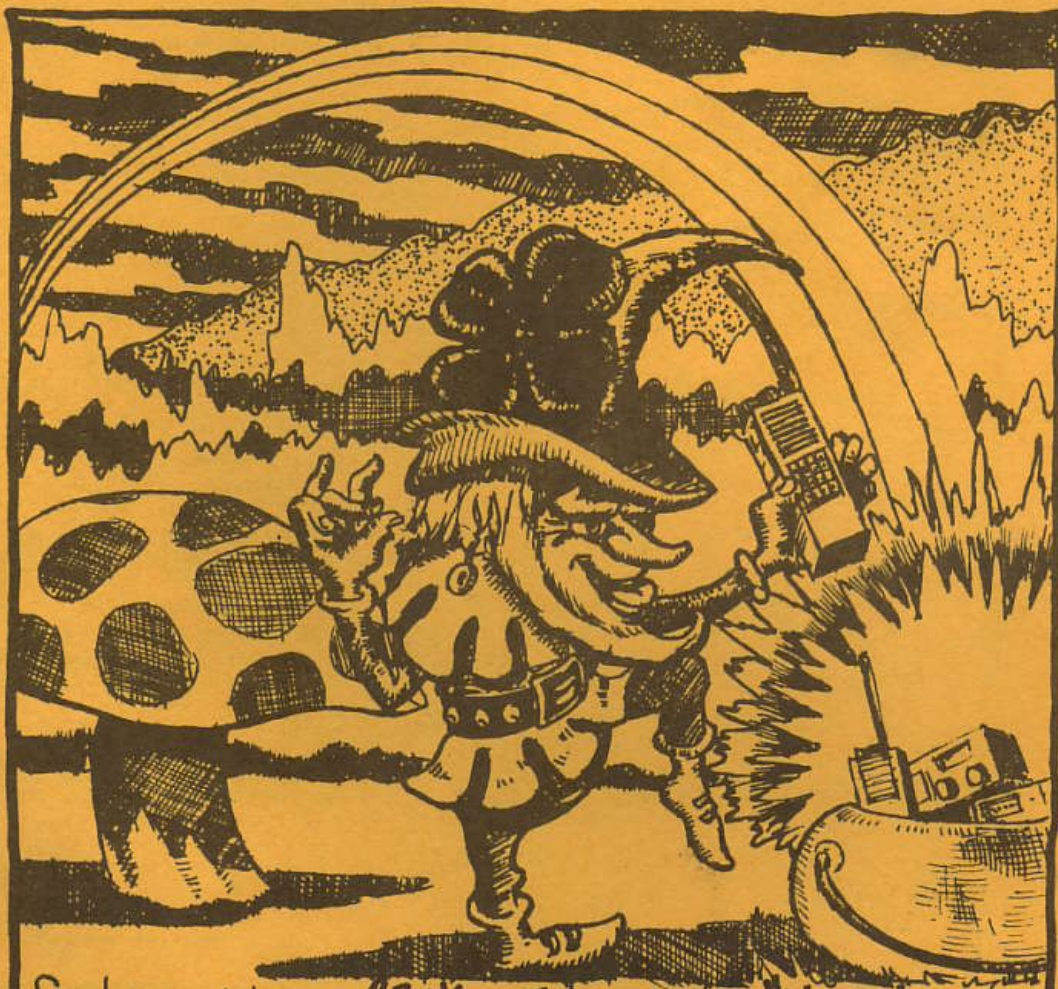

Sandra reminds you - "BE KIND TO LEPRECHAUNS" MONTH!

SW SHANKS & WRIGHT ELECTRONICS

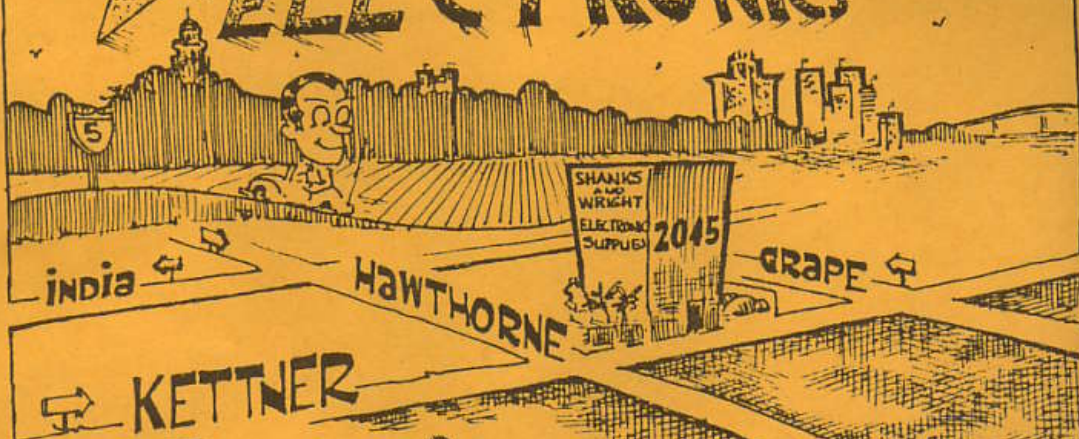

DICK

SI

OTHA

W6BZE

W6OSD

W6DWA

239-0176

EXCEPT SAT. & SUN.
(WHEN WE ARE HAMMING!)

...we are known everywhere for the quality of our parts!



2045 KETTNER BLVD.
SAN DIEGO, CA.
92138

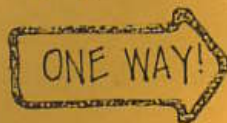

FROM THE EDITOR'S DESK

Apologies are in order to all who came to the Bonanza Restaurant on the 14th of last month. Seems like your editor forgot that the "Third Wednesday" does not necessarily come the day before the 'Third Thursday'! From now on, we will do a double check on our meeting dates to keep things straight.

Starting with this issue, (i.e., the Roster), we are using a new technique for the centerfold inserts. Removal of the single staple at the outboard edge of Squelch Tales releases the insert without disturbing the parent document. We suggest that you start keeping a file of Squelch Tales as we will be publishing Sandra notices such as Special Board Reports, Repeater Status Reports, Equipment Inventories, By-Law Amendments, and Autopatch Access Codes on a regular basis. Publication in Squelch Tales is deemed official notice to members. A cumulative index of important Sandra notices and articles is being prepared.

It has come to our attention that some of our members have been receiving Squelch Tales late or not at all. This condition has been particularly prevalent in the Imperial Valley and Yuma areas. Upon checking the bulk mail list we find that less than ten per cent of these 'non-deliveries' were due to an incorrect address or an omission from the roster. Recently, we have been double checking each label on our mailing list, (an extra three hour task). Hence, we are quite sure that at least, 90 per cent of the 'non-deliveries' must be due to mishandling by postal personnel. We suggest to members where non-delivery conditions persist, that they contact their local postal authorities regarding the matter. Remember, we are mailing Squelch Tales as fourth class mail which puts us in with the 'junk' mail. We have been told that carriers do not regard this class of mail very highly.

While we are on the subject of mailing Squelch Tales - it costs an average of 35 cents for each copy mailed out. Therefore, if any member does not wish to receive their copy please let us know and we will pull the mailing label, (Dues will remain the same).

Finally, on the subject of our advertisements - we are attempting to keep a balance between ads and articles to make Squelch Tales self-supporting, (essential to holding our full membership dues to \$10). Please give the advertisers your first priority when shopping for ham gear.



THE 'GATOR GOTCHA!



BY THE WAY!

It is hoped that none of our Sandra Simbal cartoons have offended any one. It is not intended to point a finger at any individual person but rather to serve as a reminder to us all to check up on ourselves once in a while. We are mortal and subject to being careless at times.

So we hope all will take the message illustrated in good spirit. We think this is a better way to remind ourselves of good operating practices rather than to resort to calling any one down or making a nuisance of ourselves.

Sandra Simbal will continue to be a regular feature of Squelch Tales to keep us on our toes.

LY.

JUN'S electronics

282-8682

HOME OF THE BEST BUYS

4580 UNIT L ALVARADO CANYON ROAD

SAN DIEGO 92120

THE PRESIDENT'S PAGE

On behalf of the new Board and myself I wish to express thanks for your votes and for the confidence in us expressed by many members. We all will try to live up to that vote of confidence.

First, it has been said that I, as your President, will be nothing more than a 'Yes Man' or 'Errand Boy' for certain individuals or special interest groups - Not so! I fully intend to be my 'own man' to work with the membership and the Board in the interests of both amateur radio and the membership.

Secondly, you have a fine Board with a balance in age, QTH locations, and expertise. Speaking for the Board we are planning, with the aid of many of our experienced and dedicated members, to make this year a great one for Sandra. Please help us achieve this goal by:

1. Attending as many of our membership meetings as is conveniently possible to help us conduct the business of Sandra by membership participation. Let us not be so dependent upon the Board of Directors to do every thing. Show up!
2. Attending the Board meetings from time to time, particularly if you have an important matter to present.
3. More participation in one or more of the Sandra nets. Membership response to our 'Board-on-the-Air' net is disappointingly low - don't be a 'Silent Sam'!
4. Sending in letters to the Editor (i.e., the 'Mail Box' Department) of Squelch Tales.
5. Sending in articles for Squelch Tales on technical items or items in which you believe the other members would be interested.
6. Bringing your complaints to the Board of Directors, (or to me personally). Do not take your complaints to outsiders or other clubs first. If I don't seem to respond, hit me again with it! There's a lot to do as editor of Squelch Tales and as President.

Thirdly, do not be surprised if you get a letter, telephone call, or a knock on the door --I'm going to keep in touch!

And finally, we have a bunch of new and novel ideas which we are going to bring up for membership and Board considerations. Let's make Sandra a fun, as well as a service, association!



 73's
Larry Harvey, N6LY
President

FAIRMOUNT ELECTRONICS

BEST PLACE IN TOWN
FOR CONSIGNMENT

Ed NGAQU

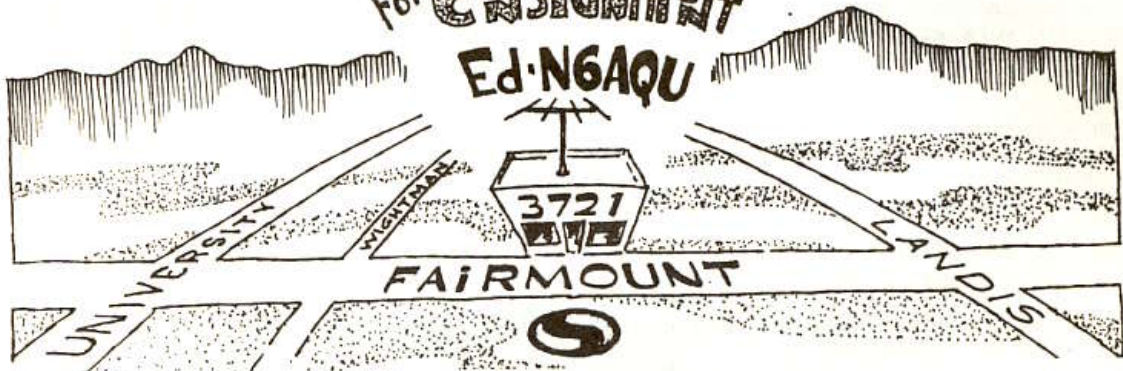

INTRODUCTORY OFFER!

2 Meter
PACE
COMMUNICATOR II

1-25 WATT
MOBILE

\$349⁹⁵

REGULAR \$399.95

10 Meter
COMTRONIX

10 WATT FM
80 CHANNEL

\$239⁹⁵

REGULAR \$269.95

AND

LIMITED TIME ONLY!

FAIRMOUNT ELECTRONICS • 3721 FAIRMOUNT AVE.; SAN DIEGO CALIFORNIA 92105

MINUTES OF THE BOARD

FEBRUARY 21ST MEETING

The meeting was called to order by the new President, Larry Harvey, N6LY at the Bonanza Restaurant, 2633 El Cajon Blvd., at 9:00 pm.

Board Members present: N6LY, WB6PMF, W6GIC, W6OR, W6GBX0, WA6AIL.

The President turned over the meeting to Wayne Ramford, immediate past President.

The next hour was devoted to hearing the following people with their views on a problem which came out of the SMA 220 Coordinating Committee.

1. Bob Radder, who had been asked by Wayne Ramford to help out in the situation, gave a detailed report on the re-coordination of SANDRA's link frequencies (two pair) to two local groups. It seems that in Nov. at a 220 SMA Technical Committee meeting, the coordination of two of SANDRA's link frequencies were pulled. No word of this action was passed to SANDRA, until W6PDA happened to talk to WB6TOP, who said that he had been coordinated to those frequencies (one pair). Then it was discovered that the other pair had been coordinated to WB6VTM's Point Loma link to Palomar.
2. W6PDA asked why in the three months that had passed since the two link pairs had been taken away from SANDRA no one had mentioned anything to SANDRA even though Bob Buaas had talked to Wayne several times regarding the new Laguna repeater frequencies. He also stated that SANDRA has money invested in the pair that went to WB6VTM, but not in the one that was given to WB6TOP. SANDRA has been using the one given to WB6VTM, Wayne stated, and the other one could be given up, but not the one that had been given to WB6VTM.
3. Bob Buaas said that it was already done and could not be undone without the total committee discussing it, but that a special meeting could be called. He stated that he had information that neither pair were being used, and that he had warned everyone at the two preceding SMA 220 meetings that they were going to pull all frequencies that were not being used. He said he would require a system diagram and RFC's for any frequencies SANDRA wished to coordinate.
4. Bob Radder offered to ask WB6VTM to hold off using the one pair for 30 days so that SANDRA could get the system diagram and RFC's in and in thirty days perhaps the 220 SMA and SANDRA could iron out their problems.
5. Wayne said that he could get the necessary information to the 220 SMA in 30 days.
6. Bob Buaas handed the president and secretary copies of the Laguna repeater coordination as well as the official notification (dated Feb. 20) that the two link frequencies had been taken away in Nov.

W6GBX0 moved that the meeting night in the By-Laws be changed to the third Wed for the General Membership meeting. Seconded by WA6AIL. Passed.

The meeting adjourned at 10:35 pm.

Sybil Allbright
Respectfully, Sybil Allbright W6GIC



N6BB PHOTO

NEW PRODUCT REVIEW

Emerson (Kas) Kasmer, AI6N, demonstrates the latest in 2-meter handheld antennas. This state-of-the-art antenna was presented to Kas by the members of the Cubic Amateur Radio Society (CARS) on the occasion of his up-grading to Amateur Extra. The antenna is constructed of rubber and has a gain of -17dB (duckie-Bels) referenced to an isotropic wet Kluskey. The new antenna is not yet available in electronics stores, but can be found at most Toys-R-Us outlets or at

your local drugstore. A suitable name for the unit has not yet been announced, but if you mention "rubber duckie" to the clerk he will know exactly what you want.

. . . . N6BB

~ ~ ~ ~ ~

MURRAY ELECTRONICS
 4898 RONSON CT. SUITE J
 SAN DIEGO, CA 92111

(714) 565-2639

Eff: MARCH 1, 1979

AMATEUR PRICE LIST

CABLES:

RG-58C/U.	\$ 8.14 per 100'	(100' Min.)
RG- 8/U	17.60 per 100'	(100' Min.)
RG-223.	40.70 per 100'	(100' Min.)
RG-213.	23.00 per 100'	(100' Min.)
RG-214.	100.00 per 100'	(100' Min.)

RESISTORS:

1/4 & 1/2 watt, 5%, Carbon Film	2.40 per 100	(50 Min.)
(ALL STANDARD VALUES)		
		(No mixes)

CAPACITORS:

Silver Mica, 5%15 ea.	(Min. 10)
Disc, under 500 Volts10 ea.	(Min. 10)

CONNECTORS:

SO-239.53 ea.	(Min. 5)
-----------------	---------	----------

POWER SUPPLIES, N.P.C.:

109R.	115.36 ea.**
108RM	77.46 ea.**
108RA	68.39 ea.**
104	43.92 ea.**

TUBES & SEMICONDUCTORS:

Call for pricing.

**Allow 4 to 6 weeks for delivery from date order was received.

Payment by CHECK, MONEY ORDER, OR CASH ONLY PLEASE!

We will ship UPS C.O.D., if desired.

MINUTES OF THE BOARD

MARCH 1ST MEETING

The regularly scheduled meeting of the Board of Directors of SANDRA, Inc. took place at the Bonanza Restaurant, 2633 El Cajon Boulevard, at 7:40 PM.

The meeting was called to order by the President, Larry Harvey, N6LY and a quorum was established. Board members present: N6LY, WA6KHA, WA6BXO, WA6AIL, WA6MDD, W6QR, and W6GIC. XE210 came in at the break.

1. The minutes of the previous meeting were read and approved.
2. The Treasurer's Report (printed elsewhere in this issue) was approved as presented.
3. It was reported that the 220 Repeater for Laguna had arrived in San Diego on Feb. 28.
4. SANDRA is suing one of our advertisers in Small Claims Court and the amount is \$240.00 and the date of the hearing is Apr. 24, 1979.
5. N6LY stated that he had talked to Bill, WB6VSA, and he is ready to broadcast WESTLINK on 04/64 Monday evenings at 8:30 PM.
6. A discussion was held about the Post Office box rent. WA6AIL moved and WA6MDD seconded a motion to ask for a half-box at \$56 per year rather than the full box we now have at \$80 a year. We will have to wait until one becomes available.
7. WA6KHA will call Ron Earl about the Leadership manuals.
8. Vance, WA6KHA will contact Bob Squire to get the roster for printing in this issue if possible, and if it is not ready it will be in the next issue.
9. Marvin Brown, WA6BXO moved that the allotment for expenses for going to Otay or Laguna be raised to \$25. WA6AIL moved that the amount be amended to \$15 instead of \$25. The amendment passed. Then the main motion as amended passed.
10. WB6AMT presented a detailed bill for the control he built for the two meter, 220, and 450 machines on Otay. The total came to \$179.30 and W6GIC moved to pay the bill. Seconded by WA6BXO and passed unanimously.
11. WA6KHA brought to the Board's attention the fact that we need a battery for back-up power, at least 120 amp hours. WA6BXO offered to buy an Astrolite 240 amp hour battery for SANDRA. W6GIC moved, WA6AIL seconded a motion to gratefully accept the donation of the battery.

REMINDER !!! GO AFTER YOUR NEIGHBORS, FRIENDS, EX-FRIENDS, AND ALL YOUR RELATIONS AND GET THOSE PETITIONS SIGNED YOU RECEIVED LAST MONTH !!!

Board Meeting (continued)

12. It was brought to the attention of the Board that we need a 20 amp power supply. Dave Olson offered to supply a free supply. W6GIC moved, WA6RXO seconded a motion to gratefully accept the donation for the power supply.
13. WA6KHA brought up the subject of PL decks for control. After some discussion, WA6KHA moved, WA6MDD seconded a motion to purchase for approximately \$150, three encode/decode PL decks. The motion passed. In addition, WB6AMT said he would donate 1 PL encoder to the club.
14. WA6BXO brought up the proposal that we have a social function on a weekend so that the members in the Imperial Valley can attend. An inquiry will go out in Squelch Tales and on the nets as to how many would attend such a function.
15. Interference: Some people on Laguna are being interfered with and it was brought to the attention of members of the Interference Committee.
16. W6OR stated that several people had requested a beep (reset) on Otay like the one on Laguna. N6LY will contact WB6AMT for advice as to who could build it.
17. WB6AMT reported that they had found an MSY MICOR repeater for Otay that was worth about \$4200 and they could get it for \$2400. He has ordered it and it should arrive in about 8 weeks. It will have to be realigned and tuned.
18. N6LY had asked the trustees for an inventory of equipment on the mountains at each site. Ed, WA6YVX, trustee of all Otay machines gave his inventory to N6LY, the President.
19. The meeting was adjourned at 9:15 PM.

Respectfully submitted,
Sybil Allbright
Sybil Allbright, W6GIC
Secretary

LEST WE FORGET

Last month, the 17th passed most of us by without notice. History tells us February 17th was the 43rd anniversary of the death of Hiram Percy Maxim. Probably only those of us who were ARRL members in the early thirties will remember the ARRL President HPM.

However, more than any other individual, Maxim deserves the title of "Father of Amateur Radio". Putting the ARRL aside for the moment, it was Maxim, who continually fought Congress and other government officials to allow amateurs to come back after World War I with their stations on-the-air.

Aided only by the then, Secretary of Commerce, Herbert Hoover, the broadcast interests and other government departments, (i.e., the U.S. Navy), were shouldered aside just enough to permit amateurs a few frequencies in which to operate their stations. We all probably do not realize how close we came to not existing! So fellows, whether you are pro-ARRL or not, remember the plucky little German-American who got us started!

N6LY

AUTOPATCH, Continued (FROM PAGE 11)

We hope to contact responsible CHP authority to explain the difference between CB and amateur radio. This may reduce or eliminate many of the unsatisfactory responses from the dispatcher.

2. A number of quasi-business calls made by members to their offices, have been noted. We caution all members again - don't make any such calls if there is the slightest chance a FCC monitor may interpret the call wrongly. We can very easily lose our autopatch priveleges - they are at risk!

Additionally, don't argue with the control operator - he has explicit instructions from the trustee - make your complaint to the Board if you feel you have a justifiable case.

CONTINUED ON PAGE 14

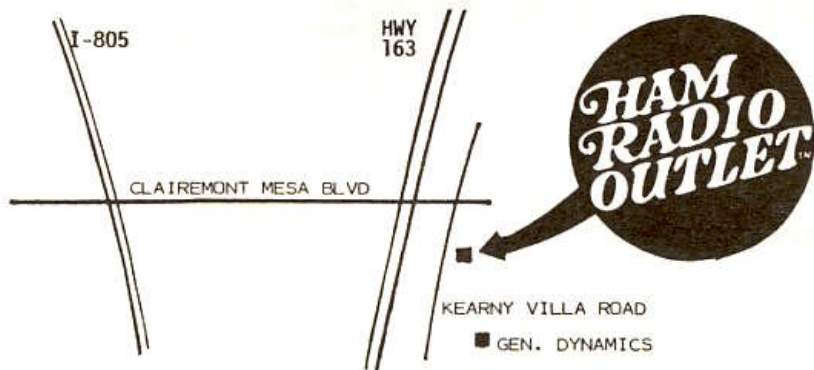

DID YOU KNOW... **HAM RADIO OUTLET** IS YOUR **FACTORY-AUTHORIZED**, STOCKING DEALER FOR
• ALDA • ALLIANCE • ALPHA • AMECO • ATLAS • BIRD • CDE • COLLINS • CUSHCRAFT
• CURTIS • DENTRON • DRAKE • EIMAC • HUSTLER • HY-GAIN • ICOM • KENWOOD • KLM
• MFJ • MOSLEY • PALOMAR • ROHN • ROBOT • SHURE • SWAN • TELEX • TEMPO • TEN-
TEC • TRISTAO • TELREX • TRI-EX • WILSON • YAESU • AND MORE! COME IN AND
SEE OUR BEAUTIFUL DISPLAY OF GEAR AND ACCESSORIES, NEW AND USED. CAN'T MAKE
IT FOR FREE COFFEE? WE OFFER **DAILY UPS** FOR OVERNIGHT DELIVERY OF YOUR ORDER
ANYWHERE IN THE COUNTY!

HAM RADIO OUTLET
5375 KEARNY VILLA RD
SAN DIEGO, CA 92123
ph. 560-4900
10 - 6 DAILY EXCEPT SUNDAY

SALES • SERVICE
— YOUR SATISFACTION IS GUARANTEED —
GLENN RATTMANN K6NA
TOM McDUFFIE KB6GU

HELPING HAMS . . .

Tucked away in the cover puzzle of February's issue is a caption entitled, "Helping Hams". This is a category that has been represented many times in past issues of Squelch Tales under different titles or 'headers' such as "Knights-Of-The-Air". We wish to continue this practice for small acts of kindness rendered the public by our San Diego hams.

Where the service provided by our local hams, and in particular, by any of our members, are critical to the saving of life, public welfare, and property of others, we publish the report under its own headline. The following is such an instance as reported by Cliff, W6MMV...

CANYON RESCUE . . .

"It was a beautiful Sunday morning, clear and warm, four trailer clubs asked me to take them to the Mountain Palm Spring Canyon on a picnic. About twenty car loads were in the caravan, approximately 100 people. We arrived right at snack time in a grove of 50 palm trees, having more fun than a barrel of people. When we left, going down the wash, a lady, Mrs. Nora Wigstrum, slipped down a four foot dropoff hitting her right ribs on a big log, breaking three ribs. We tried to move her twice and she passed out. Having left my radio in the car, I ran the mile back and with the help of Harlow, WA6LZG, we were in contact with Verne, W6EPW in Ocean Beach who made the phone call to Borrego headquarters. The young lady, Joan Parkley, called the rangers. In a matter of minutes the ranger was there. He called for the helicopter and several other rangers arrived.

Very carefully, they put her on the stretcher, then on the helo, and was brought to Butterfield Ranch. Her husband took her to Grossmont on a bed in their van. She is doing very well, all to the quick response of good old Ham Radio! Without Ham Radio, it would have taken several hours to get help, and this is one time we were all glad the repeater [Mount Laguna Repeater, WR6AJL], was working. Also take note - when there is an emergency, thanks to all the Hams standing by ready to give assistance if needed.

Thanks to all for your cooperation
Cliff Kimball
W6MMV"

Thanks, Cliff, for sending in this report. Reports such as this and the "Mountain Rescue" report of last month by Johnny, W6KBT, provide the much needed justifications for our existance as hams.

Members are encouraged to send in major items such as the above so that we may publish them for the record. We, on the staff, also solicit smaller items for our 'Helping Hams' column when we have a sufficient number to publish as a half or full page. Both the small, as well as the large, reports of hams who help, are important. Keep turning them in, fellows, we need all the help we can get - and don't forget the County Ordnance - Antenna Petitions - we need all of those we can get!!

BAUDS AND N'S

Again, this is the 'grab-bag' corner in which we put in any last minute notes or 'whatever' as we wind up this issue before we go to press.

We hope you all will find our March Membership Roster a big improvement over the 'quickie' we published last November to catch up the membership list. Also, the method of using a single staple on the outboard edge of the Squelch Tale booklet, should be a lot easier to separate the centerfold insert from the parent document. Reassembly of either document won't be necessary.

Some members have discussed using the "Thomas Brothers" book map as a means of determining or specifying the coordinates of some of our 'nameless/call-less' button pushers who like to play. This has considerable merit both in hunting down the 'undesirables' and in it's use for ARES. More on this at the membership meeting and on Sandra's Board-on-the-Air Net.

LATE SWAP MART AD FROM
WB6WHM - A GARY RADIO TYPE 3 AMP
POWER SUPPLY \$25 - 279-1820 EVE
That's All Folks!



We are in a bind if we don't get news from you!

73's
LY

REPRINTED FROM THE W6SD CARRIER

"Honest"
Monty's SURPLUS

OPTICS · ELECTRONICS

25 amp
13.6VDC
Power supplies

COAX -
RG 223
RG 213
RG 58

muffin fans

3354 Hancock
295-9781

HR REPORT HIGHLIGHTS . . .

Highlights of the HR Report are reproduced here depending upon available space and the particular importance of the HR item to the Sandra membership. The lead item reproduced below was considered by the Editorial Staff to be a real publicity 'plus' for ham radio. We take our hats off to a fine achievement by W4RHE - Congrats, OM...

- o -

IRAN'S ONLY U.S. EMBASSY/U.S. link during last week's embassy takeover was Amateur Radio, with plenty of excellent pro-Amateur Radio publicity the result. After Guerrillas entered the embassy in Teheran last Wednesday, embassy staff members had destroyed all their communications equipment. W4RHE in Orlando, who's been contacting Teheran stations regularly since the Iranian upheavals began in order to check on the well-being of his sister and her family, became the sole domestic terminal for all State Department communications. W4RHE's Iranian contact, EP2LJ in Teheran, was able to phone into the embassy during the takeover. With conditions best in Florida from Teheran, W4RHE then found himself relaying all State Department traffic between Washington and Iran for the next three days. Both 14 and 21 MHz were used for the sessions, and at one point, Secretary of State Vance himself took part in the discussions through W4RHE.

A Slot on This Week's "Today" Show was W4RHE's reward for last week's exploit, with show host Tom Brokaw leading a very positive discussion of Amateur Radio. Thanks K3ZJ, W4WLM.

A NEW 2-METER DX RECORD was set February 13, when SV1DM made contact with ZS6DN in Pretoria at 1810Z over a 7117 km path. It didn't stand long, however, as SV1AB (on the north side of Athens) worked ZS6DN just three days later - February 16 - at about the same time to extend it another 10 km. Thanks W1JR.

2-Meter DX is also heating up in the Americas - KP4ES, KP4Q, and KP4AAN all worked Argentina on 2-meter FM Monday evening, the 19th. Prior KP4--LU contacts had all been SSB or CW. Thanks KP4Q.

THAT "AMATEUR RADIO Operators Only" chain letter seems to be continuing to spread (HR Report 232). Most copies seem to be going to DXers, and come from overseas Amateurs.

As Money Is Requested, this letter is strictly illegal under U. S. law. U. S. Amateurs are advised to ignore it.

- o -

Although, not many of us dedicated "two meter/two-twenty" buffs are liable to be recipients of such letters we found the above HR Report item interesting.

We can, of course, include many HR Report news items of lesser importance than the lead article if the membership wishes. However, since many of the local club newsletters/bulletins and some on-the-air nets already include such reporting, the staff was of the opinion that only those items of special interest to UHF/VHF, or major impact to hams, should be re-printed.

3. Calls made to the autopatch repeater from a long distance (e.g., Los Angeles area), to avoid paying the toll charge, are patently illegal. If you make such calls be sure it is of a nature for which a long distance landline call would not have been made. Control operators are watching such calls as a protection of your autopatch priveleges.

Finally, control operators have been very pleased with the manner in which the Sandra membership, as a whole, are using the autopatch. Keep up the good work and don't forget to help the non-member to make his call by offering to bring the autopatch up and down for him. Also remember - our access code is still "73*" up and "73#" down.

NEWSLETTER SWAPS . . .

Perhaps some of you have wondered from time to time, if you weren't having that "Seems like I've been here before..." feeling when looking at some of our articles and cartoons. This is particularly so for some of you who belong to a number of clubs in the same section of the state, (e.g., Poway, 220 Club, El Cajon ARC, etc.). Yep! most of us editors have a 'Gentleman's Agreement' to swap newsletters between one another. By this means, we obtain a much better distribution of important news topics and technical articles. We feel certain that the greater dissemination of HR Report items keep hams better informed especially on fast moving FCC actions. We feel that the swapping around of cartoons like that below, often provides a needed chuckle. CREDITS ARE DUE THE W6SD CARRIER AND SKIP (FRESNO ARC) FOR CARTOONS ON PP. 14 & 16

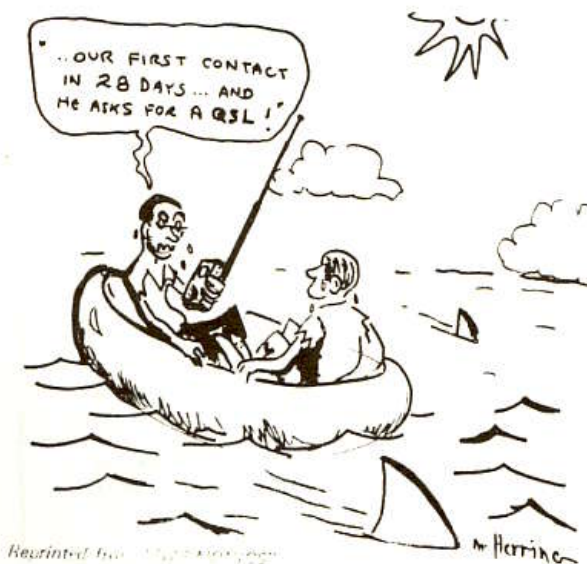

Reprinted from *QST*, 1972

ELECTRONICTOWN

ELECTRONICTOWN, THE RETAIL DIVISION OF ANKER ELECTRONICS has moved to San Diego with the largest assortment of surplus in town (diodes, meters, speakers, IC's test equipment, receivers, transmitters, and tubes and more.) Material coming in every week. Come in and browse....

MONDAY TO FRIDAY 8AM to 5PM
1st and 3rd SAT. 8AM to 2PM

Located in downtown San Diego, 440 7th Avenue, between I & J Sts., one block South of Market Street.

440 7th AVE.
San Diego, CA 92112
(714) 232-9379



'Swap Meet' ads is one that has been 'stacked' in various corners and crannies as space would permit. Now, we hope this 'formalization' will encourage you to use your 'free ad' membership privelege whenever you have a small item or group of items to list.

Also, don't forget - if you are looking for a certain piece of ham gear - send in your want ad. Maybe a fellow member might just know where you can find it.

For your convenience, we will make an effort to take your ad directly from the 'Swap Net' feature of any one of the Sandra nets provided we have your permission to publish. The latest 'on-the-air' ad to be received for publication will be after the Sunday net which follows the first Thursday of the month. Prior to this deadline, non-commercial ads may be submitted by mail, landline, or on-the-air.

- o -

FOR SALE:

Ten-Tech Argonaut Xcvr, matching linear, crystal calibrator, Electro-Voice mike -- Mint condition. \$295 for all (Cost over \$525). Call Lenny, WB6SIP at 582-9182.

WD6APA, Joe Baer has had his HW 202 Micorder and tone burst stolen from his car recently. Joe has the crystal certificate for the above rig to cover a local repeater. Will sell for \$ 4.00 now that he no longer has the rig. Phone 435-6533 for details.

FOR SALE:

Touch tone type 'Channel Guard' decoder, complete with built-in AC power supply, 'trip' light, and peeper oscillator with speaker. Decodes 4 pre-programmed touch tones to activate trip light and peeper oscillator. Unit is beautifully built and like new. Circuit diagram and 'channel guard' coding instructions included. Use this unit to monitor any of the repeaters, quietly until tripped by a calling station using the proper touch tone sequence through the repeater or direct. Call 225-8456 for price and additional details.

FOR SALE:

15 Inch Eminent Speaker, 8 ohm impedance. Sell for \$30. Call Larry at 277-6352.

- o -

[ONLY A FEW ADS FROM THE MEMBERSHIP WERE AVAILABLE AT PRESS TIME. LET'S FILL IN A PAGE OF ADS IN THE NEXT ISSUE. IT COSTS MEMBERS NOTHING TO HAVE THEM PUBLISHED IF THEY ARE NON-COMMERCIAL AND RELATIVELY SMALL ADS SIMILAR TO THOSE ABOVE - EDITOR]

7400A TRANSCEIVER REVERSE MODIFICATION

This modification permits instant reversal of input and output frequencies with a flick of the Squelch Switch on the front panel, (one click over clockwise), the unused decimal point will light on the right L.E.D. digit to indicate this mode.

NOTES ON MOUNTING

1. Locate P.C. Board when wired on top of P.D. Unit (X50-1380-10). Dimensions permit P.C. Board to fit over IC's and between shield walls.
2. Use a thin piece of polystyrene (3/8" approximately) first to insulate new board from IC's. New wires will dress along the cable harness as they come from under meter over to new board.
3. Put new board just to the left side of the crystal when looking from the front of the 7400A. Crystal case will act to hold new board.
4. Put some insulating tape on the inside of the top where the top will be over the added P.C. board.

Figure 1 shows the circuit connections for the added circuit board. Values of the components used in the added circuit are shown in the added circuit board diagram. Figure 2 illustrates the physical layout of the added circuit board components and those for the connection to the 7400A offset switch and relay, (SEE PAGES 19 & 20)

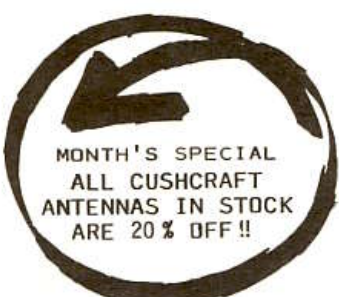

MONTH'S SPECIAL
ALL CUSHCRAFT
ANTENNAS IN STOCK
ARE 20% OFF!!





LION

electronics
427-6131

HOURS:
DAILY 9-5
SAT. 9-4

LARGE STOCK OF
220 MHZ CRYSTALS

 SANDRA'S LAGUNA 220
REPEATER CRYSTALS IN
STOCK (222.46/224.06)



Larsen
MIDLAND
INTERNATIONAL

BADGES ENGRAVED TO ORDER - SEE US!

457 BROADWAY CHULA VISTA

BETWEEN G & H

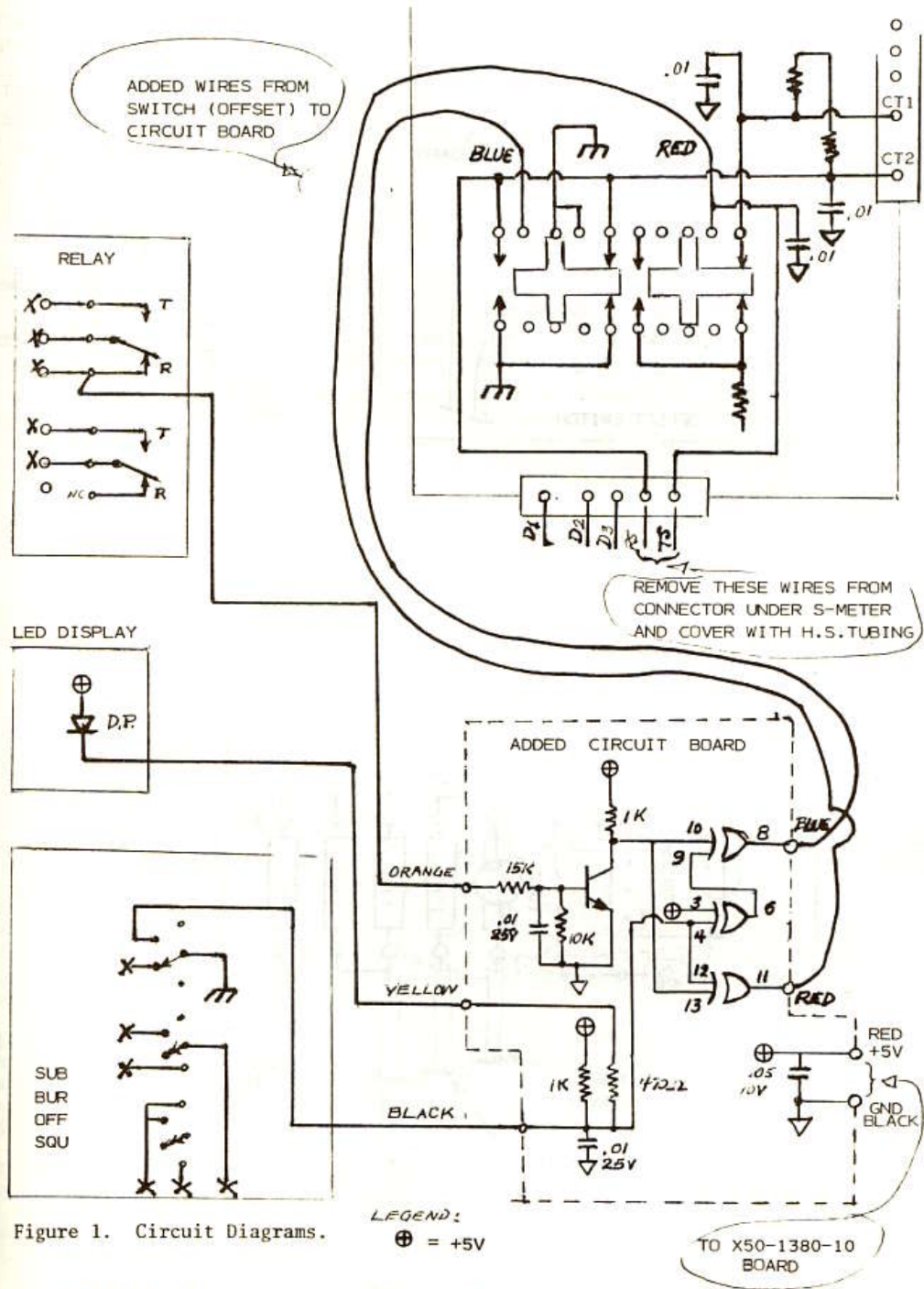

Figure 1. Circuit Diagrams.

LEGEND:
⊕ = +5V

7400 A TRANSCEIVER REVERSE MODIFICATION, Continued

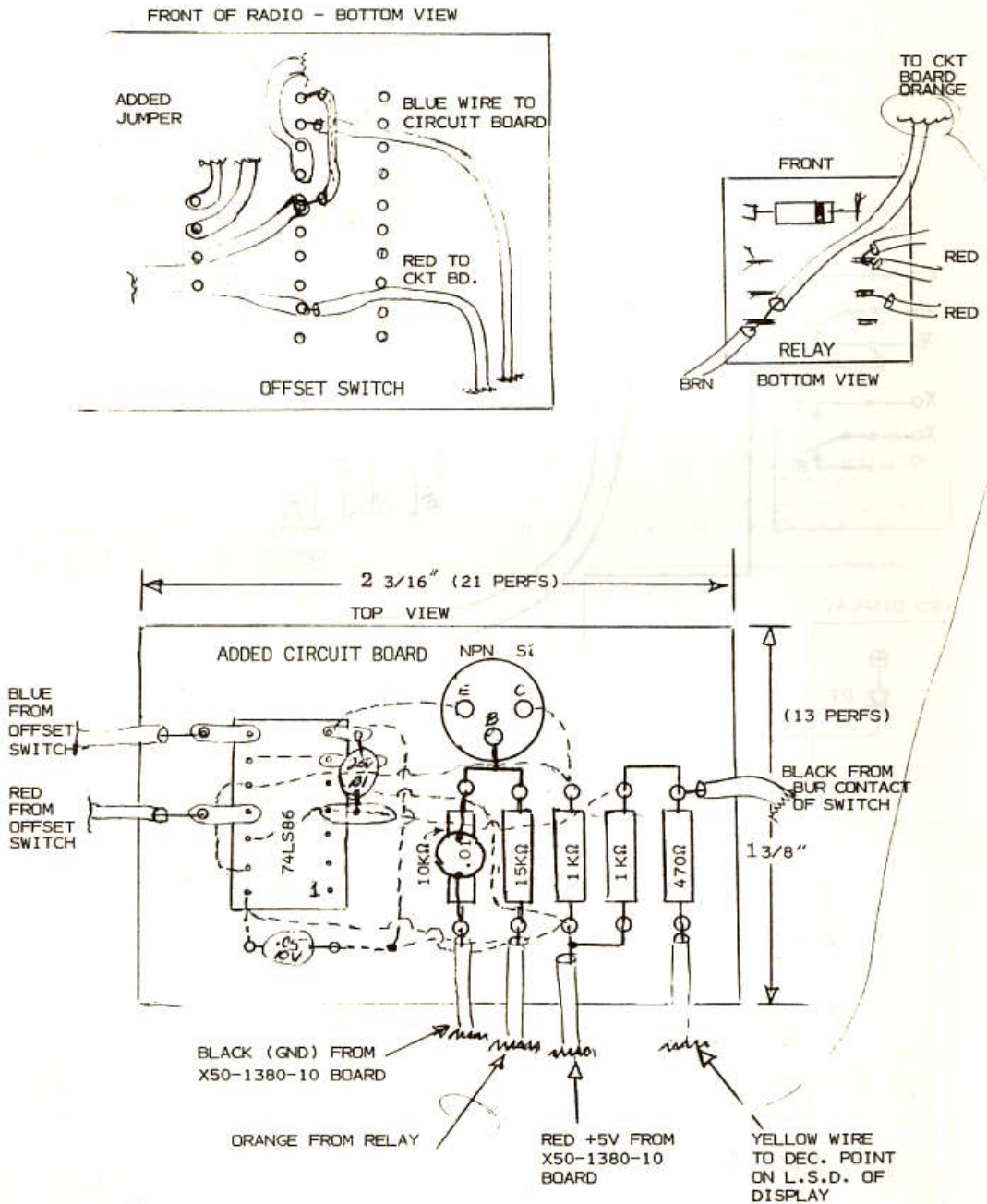

Figure 2. Physical Layout of Components.

"IT HAS BEEN RAINING....."

By Art Smith, W6INI, SCM

"SitRep: 2/17/79 0600 - It has been raining since Tuesday.....dams are overflowing..... Mass Care Centers are ordered activated as of 0600. Red Cross has been requested to provide assistance.....RACES and ARES are asked to provide necessary.....communications."

Issued by the S. D. County Office of Disaster Preparedness, the preceding situation report set the stage for the Simulated Emergency Test (SET), Saturday, February 17, 1979. The Amateur Radio Emergency Service (ARES) implemented two of its emergency communications support plans. One plan provided communications for the activities of the S. D. County American Red Cross in connection with the activation of Mass Care Centers located in high schools throughout the county. The second plan provided supplementary communications for the coordination of mutual aid for fire departments which, under flood conditions, are called upon for rescue services in addition to normal fire response.

To implement disaster communications plans is the primary function of the Amateur Radio Control Center (ARCC), which was set up in space provided by the telephone company, at the corner of Texas and Howard. The ARCC has the responsibility of locating agencies which need emergency communications, designing nets to meet their needs, assigning operators and equipment, and then monitoring the nets to ensure their efficient functioning.

For this exercise, the ARCC set-up consisted of one station on 75 meters (plus backup), one on 146.04/64, one 2-meter utility station, one 6-meter for Red Cross liaison, one 146.55 for coordinating the ARES Southern District, one 222.6/224.2, one 223.3/224.9, and two 2-meter back-up stations operating from solar power. Also available were three 120 v a.c. gas-engine generators which were used during a simulated power failure.

Red Cross Mass Care Nets operated on 75, 2 meters and 220 MHz. The 220 net, using SANDRA's Otay repeater, provided communications from the Red Cross headquarters in San Diego to its Service Centers in Oceanside, Escondido, El Cajon, and Chula Vista. A simplex net on 146.58 MHz provided communications from the Red Cross headquarters to six Mass Care Centers throughout the city of San Diego. A second net on 3.905 MHz served an additional six Mass Care Centers, also in San Diego.

Each of the four Service Centers had local nets on 75 meters and/or 2 meters connecting them with the Mass Care Centers within their areas of responsibility. Involved were a total of 17 Centers.

Participating actively in the SET were the Red Cross Director of Disaster Services, and the Service Centers managers. These Red Cross personnel provided realistically worded messages to exercise the system and acquaint operators with the Red Cross terminology necessary to develop message handling proficiency.

In the Fire Coordination System, the 220 Club's Palomar repeater provided effective communications for the primary net which had stations located at the headquarters of the San Diego Fire Department, and the headquarters stations of the Zone Coordinators in Fallbrook, Encinitas, El Cajon, and Chula Vista. Within each Zone local nets extended coordination to individual fire departments, county wide, using Palomar's 13/73 and SANDRA's 04/64 repeaters as well as simplex frequencies. At some locations, fire department personnel provided messages for transmission.

An important lesson learned from this drill is the great need for amateurs who can set up as "emergency portable". That is, the capability of moving equipment into a building and setting up a good, elevated antenna system - gain antennas preferred. Until this can be done, a greater burden is placed on repeaters when simplex would suffice. Even in accessing repeaters in marginal areas, the elevated antenna system is a vital need.

Thanks to SANDRA, Palomar ARC, and the 220 Club for the use of their repeaters.



Take a byte of the future
in home computing

APPLE II turns your color T.V.
into a personal
computer and
learning
center

WE HAVE
PRINTERS, TERMINALS,
AND ACCESSORIES FOR
ALL SYSTEMS

Centronics, Anadex, Print-Term, SWTPC,
SOROC, Micro-Term, Newtech, Micro Works,
Smoke Signal Broadcasting, Seals, APPLE,
Sanyo, Ledex, . . . etc.

for PERSONAL COMPUTING
to SMALL BUSINESS SYSTEMS
see COMPUTERWARE

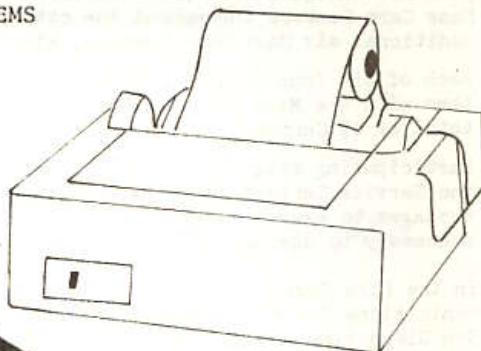

830 First Street
Encinitas, Ca. 92024

Call for our new hours or
make a personal appointment

(714) 436-3512

INTRODUCTORY OFFER!



FREE cassette recorder or
T.V. video modifier
with purchase of your
16K APPLE II computer



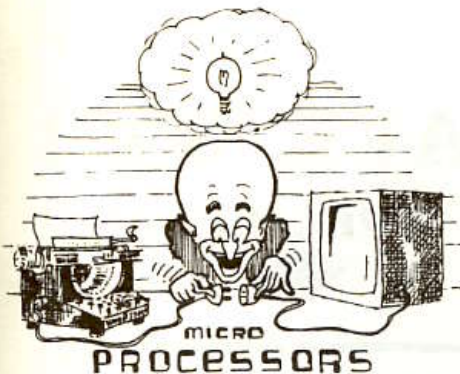

Starting here is the 'Micro-processor Department' that we threatened you with some issues back. Moreover, we must inform you at the beginning that this 'department' of Squelch Tales is not an attempt to push the 'Personal Microcomputer' hobby as such - but only to present microprocessor/computer items as they are or can be used directly in amateur radio applications. To this end we will be presenting membership and outside source information as a regular feature of Squelch Tales.

The following is a partial list of the use of the microprocessor and the microcomputer in amateur radio applications:

1. Personal contact and/or log filing - 'on-line', routine, or archival retrieval.
2. Contest logging of contacts and print outs.
3. Duplicate contact screening and new section/area identification and logging.
4. Membership roster storage, updating, and retrieval.
5. Telephone number filing and/or automatic dialing.
6. Frequency/band/mode transceiver control.
7. On-line great circle distance and bearing data for for DXing, etc.
8. Radio and electronic formula computing¹.
9. Direction finding, bearing and distance computing on-line².
10. Station-to-Station transmission of data, programs, and messages³.
11. Self-teaching programs in radio theory in preparation for license upgrading.
12. CW code practice - sending and receiving⁴.
13. CW and RTTY reception and transmission.

And the list goes on, but these are just a few of the new and challenging uses of the microprocessor/computer.

In the next issue, we will start an index or list of recent Ham-related microprocessor articles that have appeared in *73 Magazine*, *QST*, and other publications. Perhaps some day, a book may be written that is devoted exclusively to ham radio applications of microprocessors. Until then let's develop our own collections.

Notes:

1. This is an application area that would require several pages to describe, (e.g. vector equations in impedance calculations, network solutions, Fourier Analysis).
2. A critical need for locating jammers - more on this is a subsequent issue.
3. Through 'phone patch' type couplings to our ham rigs - also possible QSP by bilateral ASCII/CW methods, (at least until the FCC authorizes ASCII).
4. In addition to conventional 'tape recorder' type code practice it is possible to have a CW 'fist' measuring computer routine, to check speed and quality of how we send, (i.e., what does the CW operator at the other end of the QSO have to contend with?)

**\$30
CASH REBATE**



Model
T-16K

on this *Regency*
**16 Channel, No Crystal
Police Radio Scanner.**

Listen in to the excitement of public service band radio. It's the sound of a bank robbery, a hold-up, or a three alarm fire. And with this special rebate there's never been a better time to bring home the action. Act now, limited time offer.

**SAVE \$'s !
SPECIAL!**



ICOM 280 - \$ 399.00



	NORMAL PRICE	\$ 295
	LESS REBATE	- 30
	NET PRICE To You	\$ 265



**WESTERN RADIO
ELECTRONICS**

SERVING ALL OF YOUR
ELECTRONIC NEEDS
Since 1932

1415 INDIA STREET
SAN DIEGO, CA. 92101

P.O. BOX 790
SAN DIEGO, CA. 92112

CALL (714) 239-0361

W6KCK-Joe

WB6VTQ-A1

WA6ENU-Bob

WA6TWL-Steve

PUZZLE SOLUTION . . .

The solution to the word puzzle given on the cover of last month's issue is shown in the figure that appears to the right. It is to be noted that there are probably more combinations of words that could be made than have been shown.

We hope that you will enjoy working one of these puzzles from time to time to break the monotony of picture, cartoon, or headliner types of covers.

Meanwhile we will conjure up something that will be a challenge as well as fun to solve.

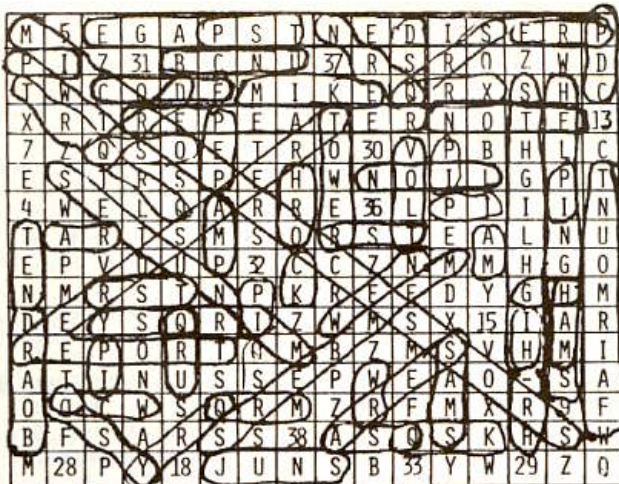

γδϵθτυξιορπασφ(λη)κω''ζχψ×βυμ~''ΓΔ+Θ+ΤΕ++&∇ΣΦ<Λ∅>§Ω^•=≡Ψααυθ~+∫γδϵθτυξιορπασφ(λη)κωζχψ×

REPEATER NOTES . . .

The Laguna 220 repeater has been delivered and is undergoing burn-in tests and checkout. The unit will be ready to go on Laguna as soon as the duplexer arrives. Try bringing up the machine.

The Otay 220 repeater has been retuned and checked as Ed and Bob, (WA6YVX and K6KGS) were up at Otay with a spectrum analyzer, tuning and cross-checking all four of the Otay 220 machines. Ed reports that most of the cross-interference problems have been eliminated.

We wish to express thanks to Ed and especially to Bob for his hard work which improved the performance of all sets involved through an upgrade in parts and the collective reduction of 'spurs' showing up on the spectrum analyzer - Well done, OMs!

NEW MEMBERS, Continued from page 26..

WB6UNB	Edgar F.	Atkins	525 Gardner St. #139	El Cajon	92022	440-0094	0280
WB6YEC	George	Runyan	7185 Baldrich St.	La Mesa	92041		0280
WA6YFI	Sylvania	Williams	6657 Osler St.	San Diego	92111	279-0774	0280
W6YLI	Marvin G.	Grigsby	11688 Foodhill Blvd	Yuma, AZ	85364	342-1899	0280
W6YNS	Chuck	Overmier	1444 Hermosa Av. Sp.64	Chula Vista	92011	420-4318	0280

-0-

To all the new members - a very big WELCOME from all of us on the Sandra Board of Directors. We hope you will enjoy meeting the other members both in person as well as on the repeaters. Our newsletter, Squelch Tales, will keep you informed of the meeting dates, Sandra nets, and other important happenings in Sandra.

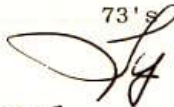
73's

 N6LY
 25



NEW MEMBERS . . .

N6ACQ	William I.	Dahlberg	9433 Emerald Grove Av	Lakeside	92040	561-4405	0280A
N6APA	Harry K.	Jackson	5157 Canosa Ave.	San Diego	92117	279-2286	0280A
WA6ARQ	Jerry	Barber	5951 Waverly Ave	La Jolla	92037	459-9365	0280
N6ASH	Glen	Hagen	4073 34th St.	San Diego	92104		0280A
WD6AWE	Daniel L.	Geisinger	139 Osgood St.	Long Beach	90805	423-0781	0280A
N6AYX	Russ	Callahan	1318 Santa Loisa Dr.	Solana Beach	92075		0180
WD6BBG	Paul H.	Bevill	18022 N.Wood Dr.	Jamul	92035	445-2267	0280
N6BCC	Danny R.	Major	10246 Laffey Ct.	San Diego	92124	571-0227	0280A
KA6BEA	Joseph M.	Barstow	6257 Lake Badin Av.	San Diego	92119	465-7231	0280
N6BEB	H.G. "Bub"	Cowan	11360 E. 195 St.	Cerritos	90701		0280Ltd
W6BFP	John R.	McEncroe	3232 Zola St.	San Diego	92106	224-1068	
WD6BRX	Paul	Brouillet	3131 Mary Lane	Escondido	92025	745-8070	0280Ltd
WA6CVM	Martin D.	Gray	3236 Caminito Ameca	La Jolla	92037	452-1764	0280
K6DUV	Willard C.	Buxton	7679 Topaz Lake Av.	San Diego	92119		0280
WD6WE	Claude L.	Kirkpatrick	1744 Pacific Beach Dr.	San Diego	92109		0280A
WB6EMS	Win	Tatro	10408 Loma Rancho	Spring Valley	92077	463-4208	0280
WD6EVR	Ted	Wiza	6355 Lake Leven Dr.	San Diego	92119		0480A
WD6EXN	Gene	Lang	6546 Wandermere Dr.	San Diego	92120		0180A
K6EZR	Ben	Schofield	1325 Rodeo Dr.	La Jolla	92037	454-5838	0380
WA6FIV	Hank	Reib	P.O.Box 662	Pine Valley	92062	473-8803	0280
WD6FKF	John P.	Hudson	612 Chester St.	San Diego	92114	264-8934	0280
WD6FME	Edward P.	Roberts	4655 Lamont St. Apt 308	San Diego	92109	273-1381	0280A
WD6FWJ	Nathan T.	Tate	3667 Spa St.	San Diego	92105	583-0736	0280
WD6FWX	W.A. Dale	Finney	214 Encinitas Av.	San Diego	92114	475-9833	0280A
WA6GGM	Shaun	Wheeler	1048 Cuyamaca Av.	Chula Vista	92011		0280
WD6HBE	Warren G.	Haynes	825 Madison Av.	San Diego	92116	295-5901	0880
WA6HYQ	John N.	Hudson III	612 Chester St.	San Diego	92114	264-8934	0280
WA6IHZ	Roger A.	Knapp	13162 Hwy 8 Sp.104	El Cajon	92021	443-7318	0280Ltd
WA6IIK	Robert V.	Steveley	5466 Burford St.	San Diego	92111	279-3694	0280A
WA6ILF	Perry C.	Clark	3958 Park Blvd	San Diego	92103		0280A
WA6IOP	Frank W.	Dytrich	7567 Melotte	San Diego	92119		0180
W7IUH	Ray L.	Thomas	6455 Van Buren Blvd	Riverside	92503		0280Ltd
KB6JH	Art	Brockmeier	839 8th St.	Imperial Bch.	92032	424-7117	0280
W6JLU	Don	Andersen	9558 Halberns Blvd	Santee	92071	562-6257	0280
W6JLW	Charles O.	Rustin	449 La Cresta Rd.	El Cajon	92021	447-8830	0280A
K6KOI	A. John	Hecht	4293 Calavo Dr.	La Mesa	92041	460-0859	0280
K6MG	Earl C.	Baker	1251 La Cresta Blvd.	El Cajon	92021	444-6193	0280A
WB6NUF	Drexter D.	Axson	2146 Lincoln St.	San Diego	92104	295-2302	0180
W6OAB	Ralph H.	Miller, Jr.	11204 Horizon Hills Dr.	El Cajon	92020	444-6098	0280A
W6OED	Eugene B.	Etchells	2086 Willis Rd.	El Cajon	92020		0280
WB6OXM	John E.	Laird	10511 Greenford Dr.	San Diego	92126	566-4178	0280
W6PU	Robert L.	Martinex	229 Lilac Dr.	El Cajon	92021	447-5246	0280
WA6PWN	C. Clif	Morris	11343 Avenida del Gato	San Diego	92126	271-1091	0280
K6QXW	William	Blair	415 So. Nardo Av.	Solano Beach	92075		0280
WA6RVB	E.W. (Gene)	Merris	6607 Thornwood	San Diego	92111	278-3557	0480A
WA6SFS	John K.	Gardella	4107 Tim St.	Bonita	92002	421-7576	0280
W6SZX	Gary D.	Fender	9616 St. Andrews Dr.	Santee	92071		0280
WA6TIQ	Edgar D.	Byrd	6830 Petit St.	San Diego	92111	277-4781	0280A
WB6TIQ	Wayne K.	Thompson	467 D Avenue	Coronado	92118		0180
WB6UCF	Kenneth B.	Sherrill	6399 50th St.	San Diego	92120	582-0214	0280A

NEW MEMBERS LIST IS CONTINUED ON PAGE 25. DON'T BE CONCERNED IF YOU HAVE SENT IN YOUR APPLICATION AND DO NOT FIND YOUR CALL AND ADDRESS LISTED IN THIS SECTION IF IT HAS NOT BEEN MORE THAN TWO WEEKS SINCE MAILING. MAIL DELIVERY DELAYS AND RECORDING TIME REQUIRED BY THE MEMBERSHIP CHAIRMAN AND THE TREASURER MAY BE THE REASON FOR NOT APPEARING ON THE LIST ABOVE.

OFFICERS

President			
N6LY	Larry Harvey	225-8456	
Vice President			
WA6BXO	Marvin Brown	465-9002	
Secretary			
W6GIC	Sybil Allbright	278-4284	
Treasurer			
W6QR	Gil Severns	224-7253	
Membership			
WA6KHA	Vance Belliston	464-2012	
Meetings			
WA6MDD	Richard Dahl	767-5687	
M.A.L.			
XE2IO	Alex Hodoyan	386-4233	
M.A.L.			
WA6AIL	Larry Cox	277-6352	
M.A.L.			
WB6PMF	Ben Bennett	344-4158	

TRUSTEES

WR6ACF - Otay	Ed Flinn (WA6YVX)
WR6AJL - Laguna	Wayne Bamford (W6PDA)
WR6ASM - Sharp	Dave Fender (K6QL)
WR6AMV - Local*	Vance Belliston (WA6KHA)

*SAN DIEGO SITE TO BE DETERMINED.

SQUELCH TALES

SQUELCH TALES is published monthly by the San Diego Repeater Association (SANDRA, Inc.), a non-profit corporation dedicated to the promotion of Amateur Radio. Distribution is free to members of the organization; subscriptions are available to others. News, views, and information exchanges (particularly newsletters and exchanges with other clubs) are desired and solicited. The right to edit material submitted with respect to format, suitability, and style is reserved. Decisions are final.

Advertisements are \$30 per page, \$15 per half page, and \$7.50 for a quarter page or business card ad. Artwork or layouts should be submitted to reach the Editor, P.O. Box 82958, San Diego, CA 92138, by the first of the month in which the ad is to appear. Assistance in preparation of artwork and layout is available at no charge to advertisers desiring this service, although a longer lead time is necessary. Contact the Editor for specific requirements. Advertisements prepared by the SQUELCH TALES staff remain the property of SQUELCH TALES and may not be used elsewhere without written permission. Liability for errors in copy or other matter is limited to the printing of a correction in the subsequent issue.

Permission is hereby granted to reprint items from this issue of SQUELCH TALES in other Amateur Radio oriented publications provided credit is given to SQUELCH TALES and, when appearing, the author. Articles are only accepted on this condition, unless otherwise noted. No liability is assumed for accuracy or originality of material. Opinions expressed, unless specifically noted, are not necessarily the position of the organization, Editorial Staff, or Board of Directors of SANDRA, Inc.

SANDRA NETS

Sunday Evening at 8:00 PM on 04/64
 Monday Evening at 8:00 PM on alternate weeks with 04/64 & 75/15 "Board-on-the-Air" nite (Schedule to be announced)
 Wednesday Evening at 7:30 PM on 75/15
 Thursday Evening at 9:00 PM following the 3rd Wednesday of the month on 04/64 "Computer Roundtable"

SANDRA REPEATERS

WR6ACF	Otay	146.040	146.640
		222.600	224.200
		*444.500	449.500
		*1-BPL	REED
WR6AJL	Laguna	220.460	224.060
		147.750	147.150
WR6ASM	#Sharp	147.285	147.885
	#SHARP HOSPITAL, SAN DIEGO		
WR6AVM	*San Diego	146.775	146.175
	*LOCAL AREA COVERAGE		

WESTLINK

Monday Evening at 8:30 PM on 04/64

INFORMATION & INTERFERENCE REPORTING

Call 286-8550

SANDRA GUIDELINES

SANDRA, Inc. operates the following repeaters for service to the San Diego area and environs. The policy of the organization is that the repeaters are available for all licensed Amateurs to use, so long as applicable rules and regulations are observed, whether members of SANDRA, Inc. or not. Further, the following priorities **must** be observed: (1) Emergency traffic, concerning the safety of life or property take priority over all other traffic. Failure to yield to any station indicating the need for such traffic is prohibited, and may render the offender subject to legal action. Indication of the need for such traffic may be "Break Emergency," "Break-Break," or any other clearly indicated statement; (2) Call-ups should be permitted. If an operator "breaks" into a conversation, he should be permitted to make such a callup. He should not, however, "take over" the repeater and exclude those who were already using it; (3) "Rag-chewing" is not prohibited, but care must be exercised to assure that the repeater is not tied up for extended periods. Remember, there are almost 400 members, and several hundred non-members, who have as much right to use the facilities as you do. It is extremely discourteous to monopolize them to the exclusion of these other users. Long QSO's should be limited to simplex frequencies or the lower bands.

SANDRA, Inc.
San Diego Repeater Association
P. O. Box 82958
San Diego, CA 92138



Circulation
Approaching
700

BULK RATE
U. S. Postage
PAID
SAN DIEGO
CA.
PERMIT
1520

Coming Events . . .

- MARCH 21 GENERAL MEMBERSHIP MEETING AT BONANZA RESTAURANT AT 2633 EL CAJON BLVD - 7:30 PM
- MARCH 24 T-HUNT STARTING AT DEL CERRO AT 7:30 PM SYBIL ALBRIGHT, W6GIC WILL BE HIDING. ALL HAMS ARE INVITED TO PARTICIPATE. BRING A FRIEND TO HELP AS 'COPILOT'.
- MARCH 29 SANDARC MEETING AT 3650 FIFTH AVENUE AT 7:30 PM. OPEN MEETING. BRING IN ALL ANTENNA ORDINANCE PETITIONS.
- APRIL 5 BOARD OF DIRECTORS MEETING AT THE EL CAJON BONANZA RESTAURANT, 7:30 PM.
- EVERY SATURDAY - HAM BREAKFAST MEETS - CHOICE OF 2:
BOB'S BIG BOY RESTAURANT, 2 BLOX EAST OF CLAIREMONT MESA BOULEVARD (EAST OF HWY 163)
COCO'S FAMOUS HAMBURGERS AT 5505 LAKE MURRAY BOULEVARD IN LA MESA.
BOTH HAM BREAKFAST MEETS START ABOUT 9 AM.
ALL ARE WELCOME!

D

92119

0679