

SQUELCH TALES

SAN DIEGO REPEATER ASSOCIATION

VOLUME VII

FEBRUARY, 1979

NUMBER 2

PUZZLE FAN?

Buried in the 16 by 16 matrix of letters are the names of our recent advertisers, many "Q" signals, and Philip's (i.e, telegraphy code) codes, and a list of almost all of the contents of this issue. Words or abbreviations may run horizontal (left-to-right OR right-to-left); vertical (top-to-bottom OR bottom-to-top); and diagonally. You guessed it! Also diagonally in four possible ways - (top-to-bottom, going to the right OR to the left), AND from bottom-to-top going toward the left OR toward the right! Page numbers for the 'Table of Contents' items are given at the end of the item.

TABLE OF CONTENTS?? LIST OF ADVERTISERS??

Confusing? Not really if you are a puzzle 'buff'. Anyway, give it a try. We will print solutions in next month's issue of Squelch Tales.

GOOD LUCK!

[EDITOR'S NOTE: WE PROMISE NOT TO DO THIS AGAIN — WELL, NOT REAL SOON ANYWAY]

M	5	E	G	A	P	S	T	N	E	D	I	S	E	R	P
P	I	Z	31	B	C	N	U	37	R	S	R	Q	Z	W	D
T	W	C	O	D	E	M	I	K	E	Q	R	X	S	H	C
X	R	T	R	E	P	E	A	T	E	R	N	O	T	E	13
7	Z	Q	S	O	E	T	R	O	30	V	P	B	H	L	C
E	S	T	R	S	P	E	H	W	N	O	I	L	G	P	T
4	W	E	L	Q	A	R	R	E	36	L	P	I	I	I	N
T	A	R	T	S	M	S	O	R	S	T	E	A	L	N	U
E	P	V	U	U	P	32	C	C	Z	N	M	M	H	G	O
N	M	R	S	T	N	P	K	R	E	E	D	Y	G	H	M
D	E	Y	S	Q	R	I	Z	W	M	S	X	15	I	A	R
R	E	P	O	R	T	Q	M	B	Z	M	S	V	H	M	I
A	T	I	N	U	S	S	E	P	W	E	A	O	-	S	A
O	Q	C	W	S	Q	R	M	Z	R	F	M	X	R	9	F
B	F	S	A	R	S	S	38	A	S	Q	S	K	H	S	W
M	28	P	Y	18	J	U	N	S	B	33	Y	W	29	Z	Q

ICOM SALE!

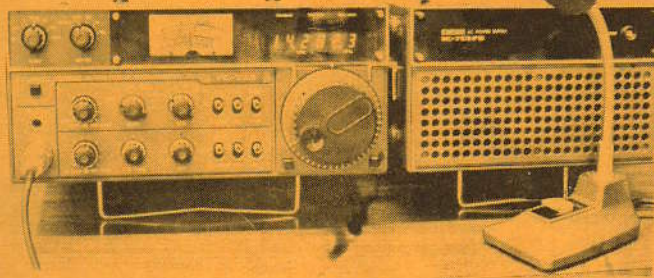

IC-701S
\$ 1,559⁰⁰

IC-245 SSB \$ 559⁰⁰

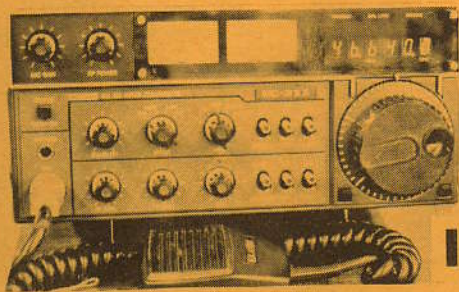
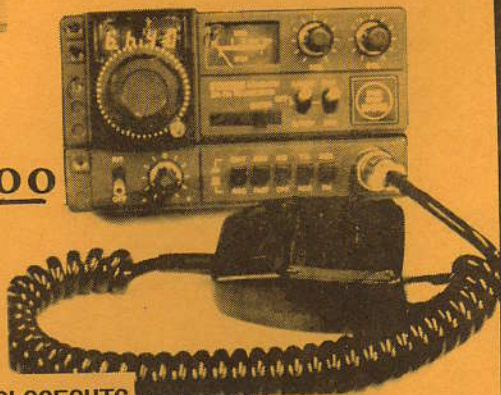

ICOM CLOSEOUTS

IC-20L \$69.00
IC-202 \$244.95
IC-211MM \$8.00

IC-211 \$ 839⁰⁰



**WESTERN RADIO
ELECTRONICS**

SERVING ALL OF YOUR
ELECTRONIC NEEDS

Since 1932

1415 INDIA STREET
SAN DIEGO, CA. 92101

P.O. BOX 790
SAN DIEGO, CA. 92112

CALL (714) 239-0361

W6KCK-Joe

WB6VTQ-A1

WA6ENU-Bob

WA6TWL-Steve

FROM THE EDITOR'S DESK_ _ _ _

If you have had some luck wrestling with the anagram puzzle on the front cover you saw some of the titles of the new topics and articles to be featured in this issue and future issues of Squelch Tales. Any suggestions or ideas you may have on these or other topics will be appreciated. Send them to the Sandra Post Office Box and they will be forwarded to me or send them direct to my QTH.



It is our hope that we can keep up the good work on Squelch Tales that has been done in the past as well as to provide new categories of information for the general membership. The following are some of the new categories planned or included in this issue:

Repeater Notes

Mail Box

Special Board Report

HR Report Highlights

Technical Tips

Microprocessors

Swap Meet Ads

Hobby Shop

ARES Page

Net Notes

We will, of course, continue the present newsletter categories as appropriate to the copy received. Some of the above categories have appeared in previous issues. Their listing here is merely to formalize them as regular items in the newsletter.

Repeater Notes will provide advisories and up-to-date information concerning repeater malfunctions, maintenance and repair, and on other matters of membership concern regarding repeater operations. It is the opinion of this writer that this type of information should be of prime importance to the membership.

The *Mail Box* will include "Letters-to-the-Editor" and reprints of letters to the association or individuals which are deemed to warrant special note by the membership.

Special Board Reports will be given under this category when the subject matter considered by the Board is of a special nature or too lengthy to be included in the regular Minutes of the Board. Special Board Reports 1 and 2 have been published. (See November 1978, and the January, 1979 issues).

HR Report Highlights, *Technical Tips*, and *Swap Meet Ads* are newsletter categories that are largely self-evident. The *Microprocessors* category will feature computer news items, programming tips, news of new computer products and programs, and other microprocessor topics of particular interest to amateur radio operators.

The *Hobby Shop* category will include items on hobbies such as flying, sailing, and photography. Notices of various hobby club meetings or events, requests to interested Sandra members to form a hobby club, and similar copy, as submitted by individual members, will be featured.

The *ARES Page* appearing in this issue and the January issue is to be a regular feature in Squelch Tales as a means for the SCM and also ARES officials to publish pertinent information concerning the Amateur Radio Emergency Service nets and functions in the areas covered by the Sandra repeaters.

The *Net Notes* category has been included in the list of categories to be added (or formalized) to draw membership attention to those nets within the Sandra coverage area. Net items for the 144-8, 220, and 450 Megahertz bands will be published.

Technical articles, news items, announcements, and other information believed by any individual member to be of interest to the membership as a whole is solicited. Information relating to emergency help given to the public by Sandra members or through Sandra repeaters is of particular interest as this is the ammunition Sandra needs to combat unfavorable legislation passed by city and county governments.

This is 'Thirty' for now, 73/s

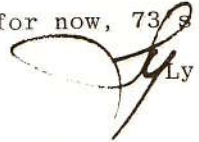

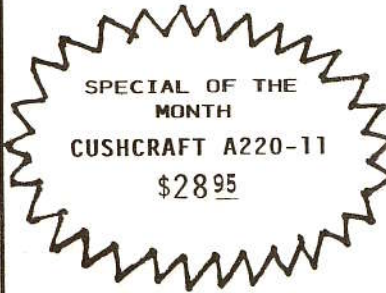

SPECIAL OF THE
MONTH
CUSHCRAFT A220-11
\$28⁹⁵

Lion



electronics
427-6131
HOURS:
DAILY 9-5
SAT. 9-4

LARGE STOCK OF
220 MHZ CRYSTALS

 SANDRA'S LAGUNA 220
REPEATER CRYSTALS IN
STOCK (222.46/224.06)



MIDLAND
INTERNATIONAL



cushcraft

457 BROADWAY CHULA VISTA

BETWEEN G & H

TREASURER'S REPORT

as of 31 January 1979

1,718.82

INCOME

Initiation	180.00
Dues	741.00
Badges	3.50
Squelch Tales	195.00
Other	
Donations	5.00
Doppler Scan	<u>65.00</u>

TOTAL INCOME

1,189.50

DISBURSEMENTS

Administration & Supplies	49.23
Rents (mt. relay)	100.00
Squelch Tales	221.00
Badges	4.24
Maintenance	10.00
(2 trips/ Otay by Ed Flynn)	
New Equipment	796.00
2-13-509/220 XCVR @ \$298.00	
2 meter RCVR @ \$50.00	
220 Repeater final payment @ \$448.00	
Other	121.50
Christmas Awards @ \$60.10	
Doppler Scan @ \$61.40	<u>121.50</u>

TOTAL DISBURSED

1,273.65

EOM BALANCE

\$1,606.35

Savings Account

Balance Fwd. \$1936.60 NO CHANGE

MEMBERSHIP MEETING . . .

February 14th is St. Valentine's Day - a time for the OM to remember his XYL with flowers and/or a box of candy. It is also the day on which at about 7:30 PM at the El Cajon Bonanza Restaurant (See the back cover for the address) Sandra holds its general membership meeting.

The program for the meeting will be a presentation by Mike Lembeck, who works for the Fish and Game Division of the Department of the Interior (I think). Anyhow, Mike has a very interesting program with slides and exhibits (of the radio gear that he uses). Mike, I am told, hooks up small transmitters to bobcats which are captured for tagging, in order to trace their movements in the wild. Mike has given this program to other ham clubs and the reports are very favorable - a good time should be had by all. CONTINUED ELSEWHERE. (WHY NOT TRY PAGE 6?).

APPRECIATE YOUR CLUB MEMBERS

It is time to put in a plug for our 535 SANDRA members, as of January 1st. Checking the 1979 CALL BOOK, published 12/1/78 (current to who knows when), I found over half our membership holds either Extra or Advanced Class Licenses.

Going down our list revealed:

- 1 Silent Key, WB6HYA Robert (Panny) Jenkins
- 5 Mexican Operators (2 new XE2 Operators joined us January 17th)
- 8 Calls too new for listing
- 1 Club Membership (Cubic ARC)

of the remaining 520 members, the 1979 CALL BOOK lists,

59 Extra	11.3%
204 Advanced	39.2
104 General	20.
2 Conditional	.6
142 Technician	27.3
8 Novice	1.6

Considering the Class listings are months out-of-date, many SANDRA members have no doubt up-graded licenses in the interim. We can be proud of the interest our group has in learning more about radio communications.

For Comparison:	Elegible for 2 meters	National	California
	Extra	7.9%	7.8%
	Advanced	28.2	30.7
	General	35.8	34.
	Conditional	4.5	3.2
	Technician	23.6	24.3

Vance WA6KHA Membership Chairman

Membership Meeting, continued

Oh Yes, by the way - there will be the annual installation of the new officers-elect to their respective offices on the Sandra Board. We all should remember, with thanks, the many hours put in by the outgoing board with Wayne, Tony, Marv, Dick, Alex, Vance, Gil (our hard working 'keeper-of-the-money', and certainly not the least, Esther Lizardi. Esther has done an excellent job as our secretary, thanks Esther. We are not forgetting the Trustees and the Technical Team, as well as Vance, our Membership Chairman who wears many hats and puts in many hours for Sandra - vy FB OM. Although, Sybil - W6GIC was not a member of the Board, she has probably donated more of her time and effort as Editor of Squelch Tales over the years than any of us. Its a hard job when one person is Editor, Ad Manager, Circulation Manager, and the Shipping Supervisor all in one, (as I am beginning to find out). Also, not part of the Board, but a group performing a very valuable service, is the group who collate, staple, and fold approximately 600 copies of Squelch Tales every month- many thanks guys and gals - from us all.

Ly

PRESIDENT'S REPORT

Fellow Members—

Another year has passed and we have met most of our goals and come short on a few others. The following is a brief synopsis of what has been done and our plans for the near future.

Our major problem a year ago was the noise on Mt. Laguna (75/15). A crew went to the hill and found part of the problem was a broken shield on the feedline. This was replaced and to verify the other part of the noise problem we mounted two antennas a few hundred feet apart. The one in the clear is used for receive and the other is used for transmit - this worked. Soon all of the feedlines will be under ground where the ice and wind cannot get to them

we have the new 220 system (220.46/224.06, thanks to 220 SMA) which will soon be in operation from Mt. Laguna. This is a clear channel. We have the crystals, also the repeater will be here soon and the rest of the hardware will be here by the last part of March. In the meantime it will operate with limited coverage on the ground for testing and burn-in. At the time the 220 is installed we will try to incorporate the emergency back-up for both hiband and 220.

On Mt. Otay we have in operation the other 220 (222.60/220.20 clear channel) repeater which has been doing very well. We had a minor problem with the audio which took 2 tries to combat. It was found to be an intermittent in the deviation pot. There are approximately 75 - 100 users on this system.

The 450 system is operating much better thanks to Ed, WA6YVZ and his crew (444.50/449.50) There is a new repeater (Micor) which we are trying to get our hands on to replace this system. More news on this next month.

The two meter system system is still the same with some intermod from the commercial 450 systems which are spaced 600 Kc apart. Another system which is in the testing stage (on the air) is the local coverage 146.775/146.175 which will help take some of the load off Mt. Otay. Its call is WR6AMV. We do not know at this time where it will be placed. If someone has a good location, contact Vance WA6KHA or Larry N6LY.

Thanks to the members who support the systems, with your help it will work. For \$10.00 a year we have 5 operational repeaters and the autopatch and two more repeaters coming on line shortly. Thats something less than 15¢ per month per repeater. Where else can you get a better deal unless you freeloader? Expenses have doubled and are going to get higher, yet our dues are still the same. All it takes is one emergency and this makes all the hard work that goes into the systems worth while. We have had major rescues in the desert, the airplane crash in San Diego, Rescues in Baja, etc. Thanks to the hams who were there when needed, and to Sandra and the repeaters which are available 365 days a year.

Next is the autopatch which has been in operation for a couple of years. Just recently we made a few changes _

A - Three digit up/down code (for member information only, but any member can and is encouraged, to bring the phone up and down for anyone who requests it).

[REMEMBER: THE WR6ASM AUTOPATCH UP AND DOWN CODE IS '7 3 *' UP, '7 3 #' DOWN - ED]

B - A control/monitor is present any time the patch is in operation.

C - When the patch and repeater are on, a dual tone will be present. When the patch is off - a single tone is present. (This will be changed to more distinct tones).

Soon we are going to change the patch time-out timer; instead of dropping the patch at the end of the 3 minutes a busy-type tone will come on for an additional 3 minutes, then the patch will drop. This will help with the emergency calls which usually take more than 3 minutes.

The next two things we are going to work on which might take some time to accomplish are__

A - All touch tones through the patch will be muted. If you hear a tone come through this will indicate the decoders don't like your tones or there is something wrong with your tones, (i.e., level, frequency, balance, distortion).

B - Auto patch linked to the Mt. Laguna 220 system, 46/06, (proposed) and not to 75/15. More news will appear in Squelch Tales as we have it.

Last, we have the extended coverage to parts of North County as far as Del Mar and Poway. Note from 8 AM to 8 PM, each call is monitored (metered by the telephone company). When the total of all calls, so made, add up to a total of approximately 1 hour in one month, each additional call made in the extended coverage area will cost the club 10¢ per minute. From 8 PM to 8 AM, it is free time so try to keep your calls in this period.

Another new program which has been initiated is the "Board-On-The-Air" night which is every Monday at 2000 hours, alternating between 04/64 one week and 75/15 the next. This gives the members on the air a chance to meet and talk to the Board members as well as keeping aware of the latest happenings.

Also we have another new net - the "Computer Roundtable" which is on 04/64 at 2100 hours on the Thursday following the 3rd Wednesday of the month. The third Wednesday is the General Membership meeting night. This is for up to 1 hour with a roundtable discussion relating to computer software, hardware, ideas, questions, etc. The net is open to everyone.

One more new net is Westlink which is scheduled to start soon. It will be on 04/64 Monday nights at 2030 hours. This is the amateur news service which is compiled in LA and is the latest in news related to hams and amateur radio with the real people involved in the event doing the reporting. Stay tuned and pass the word!

Now, to some of the behind-the-scene projects which are important, as well. The membership roster is completely computerized thanks to Bob, N6AFB. This has taken a lot of hard work but it makes it so much easier for the rest of us who need the latest membership information. Also, all the mailing labels are computerized. Note: If you have corrections, contact Vance - WA6KHA on the net Mondays or mail to the P.O. Box or make a call to the club phone and leave the message (714) 286-8550. If folks need membership information give them this number and have them leave their name and address.

MINUTES OF THE BOARD

The meeting of the Board of Directors was called to order by President Wayne Bamford, W6PDA at 8PM on February 1, 1979, at the Bonanza Restaurant on El Cajon Blvd.

Members present: W6PDA, WA6KHA, WB6AMT, WA6NEH, N6LY, W6QR
absent: WA6MDD, WA6BXO, XE2IO

Minutes: Approved as published.

Treasurers Report: Published elsewhere in this issue, not available at meeting time.

Squelch Tales:

The board agreed that this issue of Squelch Tales carry copies of the antenna petition.

A summary of rules as requested by the editor will be made available at the Membership meeting.

Interference:

Reports have been received on our interference number re: current interference on 04-64. More coordination will be made with the owners of Dop-Scan systems for future investigations of the problem.

Community Radio Watch:

San Diego Police Officer Les Nuhn (WA6QVW) was present to update the board members regarding the progress in including 2 meter radio's as a part of the system. So far they have been unable to find a radio to use, but are still looking. Information is enclosed in this issue of squelch Tales for interested members to join. If you have any further questions, please call the Crime Prevention Office at 236-6821.

Tower Information:

W6OGC, Jim Allen is still requesting information on your towers. The address to send this information should appear on the enclosed petition.

The 220 SMA Petition for Reconsideration was briefly discussed.

220 Repeater

The repeater is fully paid for and crystals have arrived. It is hoped the repeater will arrive the weekend of Feb. 3. The duplexer is to be shipped on Feb. 14, 1979. The channels are 222.46, 224.06. These are clear channels with no other repeaters coordinated on them.

Batteries:

Astro-lite batteries will be investigated for use as back-up power. WA6BXO has already indicated he will follow up on this.

OTAY

Many trips have been needed lately. The delay drop-out on 04-64 was caused by a cold solder joint. Also, 450 has been retuned to improve the signal. Other intermittent problems have yet to be solved. The requested beeper on 04-64 will not be included until the other problems have been solved.

New 450

A Micor(solid state) repeater has been ordered by a Motorola Sales Rep at this time. All options necessary for our needs will be available, and he is attempting to assist us in receiving the most for our money possible.

Autopatch:

A dual tone is present when the patch is up, and a single tone indicates it is down. The 3 digit code is now in effect. K6QL is adding control operators gradually, with the goal of 24 hour coverage.

Club members have the access code, and are happy to, and encouraged to assist stations to make a call.

Investigation is being made of providing a 4 minute extension for patch phone usage through use of a tone, or tones.

Inventory

An inventory is being taken, with all Sandra property being tagged, marked, and logged.

P.O. Box

A smaller post office box has been requested to better suit club budget and needs. We are awaiting availability of the smallest or the next to smallest size, and credit will be received for the difference when this change is made.

Program:

There is no firm program for the General Meeting at this time.

Election:

Ballots will not be sent out as the nominations were moved closed with one person running for each office. The new slate of officers will take the reins after the General Membership Meeting in February.

Dues:

Dues will be paid to ASM 144 (SCRA) and SMA 220 at \$8.00 per machine.

The Humane Society is totally reorganizing, and will be notifying us of the changes in the near future.

Westlink will be made available on Monday nights at 8:30 PM on 04-64 only.

The meeting was adjourned at 9:45 PM.

Respectfully submitted,



Esther Lizardi, WA6NEH
Secretary

SW SHANKS & WRIGHT ELECTRONICS

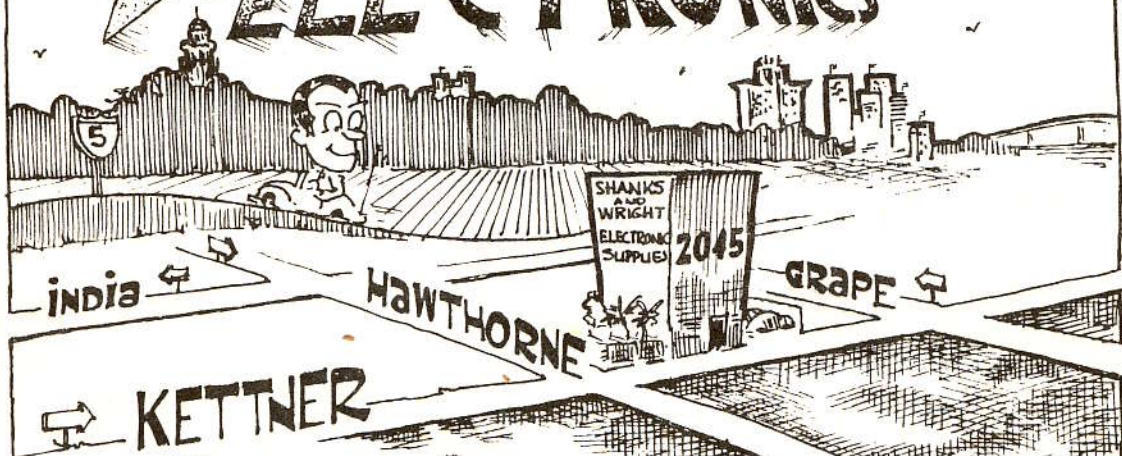

DICK SI OTHA
W6BZE W6OSD W6DWA

239-0176
 EXCEPT SAT. & SUN.
 (WHEN WE ARE HAMMING!)

...we are known everywhere for the quality of our parts!



2045 KETTNER BLVD.
 SAN DIEGO, CA.
 92138



MOUNTAIN RESCUE

This report comes from Johnny Johnston, W6KBT, who is well known to Sandra members as the ham who is always there when a need arises. The following, recorded during an interview by this reporter, will illustrate how Johnny has supplied the communications which has saved lives and has served so many.

Johnny's job in working with our rescue people as well as with our neighbors to the South, is to keep Bill Bradley of the Sheriff's Aero Squadron informed, along with Terry Hughson of the San Diego Mountain Rescue Team.

During the last week in January, more than four feet of snow built up on Mn. Del Diablo at the site of XE2SPM and the University of Mexico Observatory. The snow storm had completely isolated the nine men at the observatory, necessitating a rescue effort since they were running low on critical supplies. An attempt was made to make air drops to the stranded men to keep them going until rescued. Out of 8 packages dropped only 3 were retrieved. The other 5 packages, because of high winds, landed out of the drop zone and buried themselves down the mountain. At this time, the men were too exhausted to dig them out and carry them up to where the supplies could be used.

Also, about this time, W6KBT was asked by Chief Engineer Frade at Ensenada, the supervisor of the group at the observatory, to look into the possibility of renting helicopters in San Diego, to make the rescue trip. The plan was to fly three men at a time down from the observatory to Melling Ranch where a fixed wing aircraft, supplied by the Sheriff's Aero Squadron was to fly all of them to Ensenada. After learning of the cost to rent helicopters, (\$300 to as much as \$800 per hour), Frade made a request to the U.S. Coast Guard, who referred him to Scott Air Force Base in Illinois for coordination. Because of time factors, a helicopter was rented from a San Diego firm to make the trip.

Now, putting it into Johnny's words as transcribed from the tape.... "At 1044 hours on the 28th I was standing watch on the SPM 37/97 repeater when suddenly Aida Melling comes in on the radio and says 'Mayday, Mayday'. It is the first time in my memory that a Mayday ever occurred on a San Diego repeater, (i.e., U.S./Mexico repeaters), but I answered the call and told Aida to go ahead. . . Everything went fine until the helicopter started following the road up the mountainside toward the observatory. At 8,000 feet they got a 'White Out' - a white out is where the snow is so thick that the pilot can no longer see. With his vision blocked completely, he crashed into a 60 degree embankment, broke off his mast, rolled and collapsed his bubble, landed in an arroyo, and crawled out with only minor scratches..."

Johnny said that these men would have been killed under ordinary circumstances. As it was, the pilot and his passenger were able to walk the few miles to the top of the mountain to join the stranded group. Thus, there were now eleven men to be rescued instead of the original nine.

CONTINUED ON PAGE 15

\$\$\$\$\$

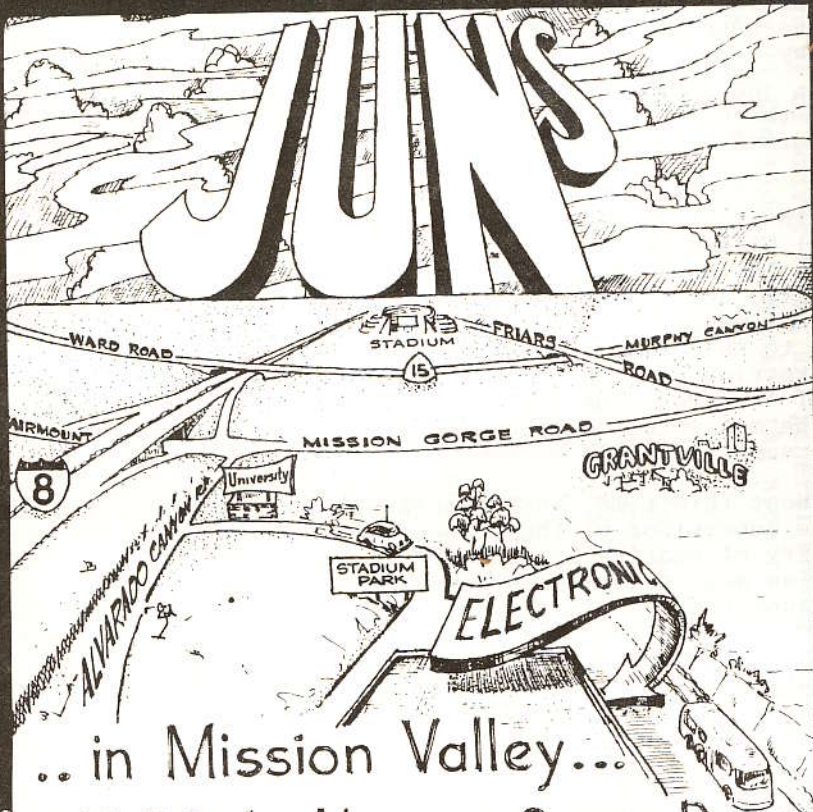

TRADES

SAVES

.. in Mission Valley...

4580-L Alvarado Canyon Road

San Diego, California 92120

call 714 282-8682

hard to find.. harder to beat !!

SERVICE IS NO PROBLEM TO US

\$\$\$\$\$

CONTINUED FROM PAGE 13

An inquiry on the cost and availability of snowmobiles for the trip to the mountain top resulted in determining that they were available at \$50 per hour from Big Bear. However, being 8 to 9 feet long and weighing 300 pounds each, ruled out the practicality of flying them to the place where they would be used in the ascent on the mountain.

Because of the growing seriousness of the situation, the head of the Observatory, Dr. Pulveda, was contacted in Mexico City. Arrangements were made for funding to provide further assistance to the local group in the rescue effort. Father Padre Keeno's group in Mexicali was also contacted to assist but when informed of the four feet of snow declined. Father Keeno said his group would not be able to go since they did not have the equipment for the trip, (i.e., did not have 11 pairs of snow shoes required by the team and none were available).

Three Mexican jeeps with the San Diego rescue team started by road up the mountain. Fuel trucks, sent from Ensenada to supply fuel to the planes which were to be used to fly all personnel to Ensenada, mired down in the mud at San Selmo, delaying their arrival at the Melling Ranch. Communications at the Melling Rance to the observatory and rescue groups was dependently almost entirely on XE2SPM. To add to the difficulties, XE2SPM had to be put on batteries due to the lack of generator power. Apparently, it was fortunate that most of the critical communications had been accomplished when XE2SPM's batteries finally gave out.

About this time the three Mexican jeeps reached the top. Everyone, including the helo pilot and his passenger, were fine. However, at this point (1630 hours on January 28th), the weather was closing in rapidly on Mt. Del Diablo, with visibility almost zero. Because of this weather, there was no possibility of the entire group coming down before night fall, and the group elected to start down in the morning.

As this report is closed, we have been informed that all personnel from the observatory have been brought down and returned to their home locations, safely.

Δ Δ

EDITOR'S NOTE: BECAUSE OF THE SHORTNESS OF TIME BEFORE PRESS DEADLINES, WE HAVE HAD TO EDIT THE COPY RATHER HEAVILY AND WITHOUT CHECKING THE CORRECTNESS OF THE COPY WITH W6KBT. JOHNNY, W6KBT WISHES TO GIVE CREDIT TO THE MEXICAN AND U.S. HAMS AND PEOPLE WHO HAVE ASSISTED IN THIS RESCUE EFFORT. THEREFORE, IN THE NEXT ISSUE OF SQUELCH TALES THE PUBLICATION STAFF WILL CONTINUE TO FILL IN ON THE RESCUE STORY AND ALSO TO PUBLISH THE APPROPRIATE CREDIT LINES.

IN OUR STORY ABOUT THE EMERGENCY AT CARRIZO IN THE ANZA BORREGO DESERT STATE PARK AT WHICH WA6CPG PROVIDED THE INITIAL CALL FOR ASSISTANCE, (PAGE 9, JANUARY 1979 ISSUE) WE NEGLECTED TO INCLUDE CLIFF, W6MVV, WHO ALSO ASSISTED IN THE EMERGENCY CALL. OUR APOLOGIES, CLIFF - YOU, WITH JOHNNY, W6KBT; BOB, WB6RHL; LARRY, WA6LAW; AND OTHERS, ARE ALWAYS IN THERE WHEN HELP IS NEEDED!



SAILORS B' AWARE!

Notice to all amateurs who own a sailboat of 20 foot or over who would like to form a cruising club, for a possible stop-gap between yacht clubs and marine activities! As a cruising club, we might coordinate day or weekend trips to favorite spots such as Catalina, Oceanside, Mission Bay, the Coronado Island, or Ensenada, with occasional regattas with limits to the rigging (up to 150% genoas, etc.). The cruising club could be open to all interested yachters but should

be ham radio coordinated and organized. This would be a great opportunity to learn better sailing and safety while having fun with ham radio -- two great hobbies!

If interested, please contact me - Barry 'Lee' Cohen, W6MUX, by phone (272-0139) or a postcard sent to 3588 Merrimac Street, San Diego, California 92117. If enough interest we will have a meeting to discuss plans and club formation. TNX, 73's.

The above article or announcement by Barry is an excellent example of the type of item we would like to carry in Squelch Tales from time to time, under our *Hammy Shop* category. What's wrong with trying out your rigs as 'Maritime Mobile'?

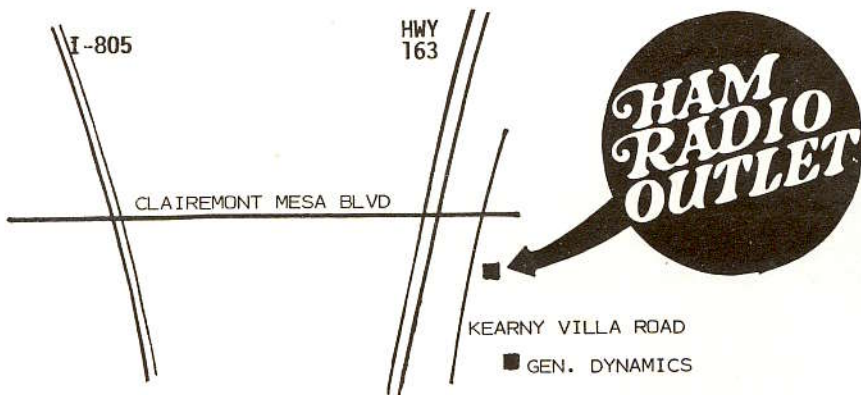

DID YOU KNOW... HAM RADIO OUTLET IS YOUR FACTORY-AUTHORIZED, STOCKING DEALER FOR

• ALDA • ALLIANCE • ALPHA • AMECO • ATLAS • BIRD • CDE • COLLINS • CUSHCRAFT
• CURTIS • DENTRON • DRAKE • EIMAC • HUSTLER • BY-GAIN • ICOM • KENWOOD • KLM
• MFJ • MOSLEY • PALOMAR • ROHN • ROBOT • SHURE • SWAN • TELEX • TEMPO • TEN-
TEC • TRISTAO • TELREX • TRI-EX • WILSON • YAESU • AND MORE! COME IN AND
SEE OUR BEAUTIFUL DISPLAY OF GEAR AND ACCESSORIES, NEW AND USED. CAN'T MAKE
IT FOR FREE COFFEE? WE OFFER DAILY UPS FOR OVERNIGHT DELIVERY OF YOUR ORDER
ANYWHERE IN THE COUNTY!

HAM RADIO OUTLET
5375 KEARNY VILLA RD
SAN DIEGO, CA 92123
ph. 560-4900
10 - 6 DAILY EXCEPT SUNDAY

SALES • SERVICE
— YOUR SATISFACTION IS GUARANTEED —
GLENN RATTMANN K6NA
TOM McDUFFIE KB6GU

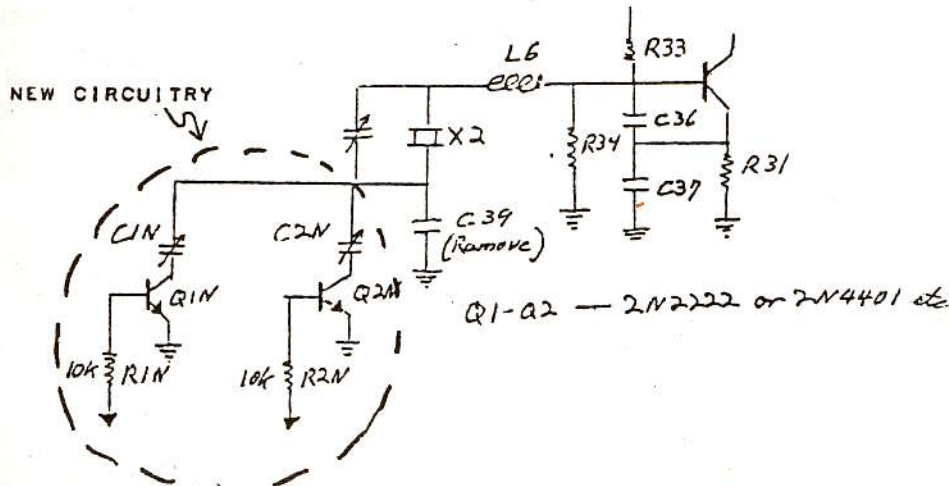

THE IDEA BEHIND THE MODIFICATION IS TO MOVE THE TRANSCEIVERS FREQUENCY DOWN EITHER 5KHZ, 10KHZ OR NOT AT ALL.

C1N IS SELECTED FOR A 5KHZ CHANGE
 C2N IS SELECTED FOR A 10KHZ CHANGE

R1N IS CONNECTED TO THE LEAST SIGNIFICANT PROGRAM BIT OR DO COMMMING FROM THE DIODE BOARD.

R2N IS CONNECTED EITHER TO A DIODE OR DIODES AS SHOWN

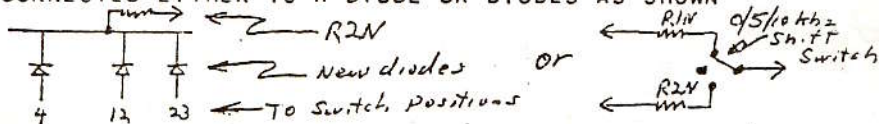

AN EXAMPLE WOULD BE: POSITION 12 MIGHT BE PROGRAMMED FOR 147.03 THE NEW FREQUENCY DESIRED IS 147.02....A DIODE CONNECTED FROM POSITION 12 TO R2N WILL MOVE THE RADIO FROM 03 TO 02 OR DOWN 10KHZ....R2 COULD BE CONNECTED TO AN EXTERNAL SWITCH.

IF YOU DO NOT WISH TO PERFORM THE MODIFICATION OR YOU WOULD LIKE MORE TECHNICAL INFORMATION CONTACT BOB ST ANDRE, WA7NAN 16750 S.E. 45TH ST. ISSAQUAH, WASHINGTON 98027. MODIFICATION OF THE RADIO BY BOB WILL BE PERFORMED FOR 27 TO 32 DOLLARS DEPENDING ON THE PARTS REQUIRED (SOME RADIOS TESTED REQUIRED A NEW CRYSTAL).

FOR ADDITIONAL COPIES OF THIS MATERIAL SEND A SASE TO WWARA.

BOB IS EMPLOYED AS A SPECIAL EQUIPMENT ENGINEER FOR PACIFIC WESTERN ENGINEERING CORPORATION IN BELLEVUE, WASHINGTON. HE HAS CONSIDERABLE EXPERIENCE IN THE DESIGN AND REPAIR OF AMATEUR RADIO VHF FM EQUIPMENT AND IS ONLY TOO HAPPY TO ASSIST THOSE WHO WOULD LIKE TO MAKE THIS CONVERSION...ADDITIONALLY HE IS A BOARD MEMBER OF THE WWARA.

Credits to the TARCO BULL, Western Washington Amateur Relay Association
 and to TELRADS Newsletter Squelch Tales 8515 Idlewood Dr. SW Tacoma 98498

This is the 'grab-bag' corner to put any miscellaneous items or notes left over into while winding up the last of this issue of Squelch Tales (at 3:30 AM on press day!). First off, all members are to be reminded that Jim Allen still wants Sandra members to send in to him all the dope on your beam antennas as a background for analysis to argue against the county's ordinance on antenna height in the unincorporated county areas. Jim wants your address, height of antenna, type of antenna, and when did it go up.

Be sure to read the 'Presidents Report' over carefully. Wayne has put in a lot of effort in preparing it and it is a virtual 'State-of-The-Association' report to the membership.

More control operators have been added to the list for the autopatch hence all should be finding the autopatch up more often than before. Be sure to keep the January issue of Squelch Tales around for awhile for reference on operating the autopatch. The access code is once again - 73* UP and 73# DOWN - so be carefully in punching the buttons. -30-



MONTY-WBGDIT
-OF THE "CLAN MCINSKO"
(FOUNDERS OF GOODWILL)

Schlo Meister*
MONTY'S SURPLUS

SeaWorld

Sports Arena

FedMart

THE PINK PLACE

3354 HANCOCK
 opposite Dixie

Electronics
 Optics
 Pneumatics

ROSECRANS
 EXIT
 MISSION VALLEY

CAMINO DEL RIO

* UNAFFILIATED!

RAIN, FLOODS, AND EMERGENCY COMMUNICATIONS

By Art Smith, W6INI, SCM

My article last month alluded to the simulated flooding situation as the background for the February 17th Simulated Emergency Test (SET). A preview in reality took place on January 31, 1979, when, as a result of heavy rains, the San Diego County Office of Disaster Preparedness (ODP) asked ARES to augment regular RACES operators as several mass care centers were opened. These centers provide food, shelter, and medical services to families evacuated from their flooded homes.

Responding to the call were W6MIR and WB6RJB assigned to the Santee Elementary School, K6AM to the Allen Elementary School in Bonita, and WA6SHI with W6QLJ to the Lincoln High School in San Diego. Later, providing relief were WB6TQF and K6OWU to Lincoln High, and WB6PVE to Allen Elementary. Standing by for assignment but not needed were WB6VSL, WB6PVH, W6OGC, and K6UV. Coordinating assignments in their respective Districts were WA6UFY, WA6UAZ, and W6INI. The primary repeater for the operation was the Palomar Amateur Radio Club's WR6AII (146.13/73) due to its accessibility to all locations which were activated as well as a number of potential sites for mass care centers in other areas of the county.

While mass care centers are set up to accommodate an estimated maximum number of evacuees, often only a handful show up. Most prefer to stay with friends and relatives. Staffing a center is primarily done by Red Cross Disaster Action Teams (DAT) although other community volunteers may assist.

We amateurs can greatly improve this type of operation by being prepared to set up and operate as a field portable station rather than mobile configuration. Equip yourself with a 120 v a.c. power supply (or drag in your car battery, if no 120 v power), a good gain antenna (such as a small beam, Ringo, or J types), at least 100 feet of low loss RG-8 or better, 20 to 30 feet of masting, guy lines, stakes, and, perhaps, a vent pipe bracket. A mobile antenna, which requires a ground plane, is generally unsatisfactory. A good antenna installation will allow you to set up indoors, access more repeaters for greater communications flexibility, and enhance simplex operation to reduce traffic on repeaters.

Why set up inside a building when mobile is so much more convenient? But is it! The customer can be served more effectively when you are within sight. They can see you. You can locate people easier. A side benefit is a better opportunity for publicity when the news media are on the scene. Sitting alone out in the rear parking lot in the cramped front seat of your car is the hard way to go.

Tips for the Emergency Operator. Maintain a business-like posture on the air and avoid chitchatting, giving signal reports, and being an endless fountain of speculative information. When you receive an official inquiry for information relative to your assigned location, contact a person who has an official capacity such as the Red Cross team leader, shelter manager, or on-the-scene government official. Learn the names of key people and when you report information you obtain from them indicate the name and/or title of the person from whom you obtained the information. When feasible, put incoming information/messages in writing. The same for outgoing. Use modified ARRL message format so that all vital information is transmitted and received. Thus, to be efficient you should carry a good supply of message blanks. It's good PR!

Tips for the Non-Participant/Listener. Contain your curiosity! Stay off the air. Don't ask questions. Much can be learned in a few minutes by just listening. If repeater operation is restricted, use it only if you have important matters that need handling. And last, but not least, don't ask if you can help unless a call for volunteers has been put out.

N
6
A
DU
CK
U

under the
spreading
chestnut tree...
... on the southside of Woodside.

SAM'S

AMATEUR
RADIO

N
6
DALE
BU



OPEN AT ODD HOURS - EVEN SOME EVEN ONES

24 HR. SERVICE - MORE OR LESS

11125-B WOODSIDE AVE.
SANTEE, CA. 92071

449-2626

SOUTHERN CALIFORNIA 220 MHZ OPEN REPEATER LIST - FEB 1979

222.20 - 223.80	WR6ANI	LONG BEACH	MOVING FROM 22-
222.26 - 223.86	WR6ANF	RESEDA	OPEN (CLOSED-AU
222.28 - 223.88	WR6AUA	CHULA VISTA, SOUTH BAY	OPEN
222.30 - 223.90	WB6LHK	CANOGA PARK, OAT MT.	OPEN
222.32 - 223.92	K6TZ	SANTA BARBARA, SANTA CRUZ IS	OPEN
222.34 - 223.94	WA6NTW	LOS ANGELES	OPEN
222.36 - 223.96	N6ZF	SANTA BARBARA, BDCAST PK	OPEN - RACES
" "	WR6AZN	TABLE MT. MOJAVE DESERT	OPEN (WR6APS LINK)
222.38 - 223.98	WR6AFG	JOHNSTONE PK, SAN GABR VY	OPEN
222.40 - 224.00	WR6AWF	CRESTLINE	OPEN (CLOSED-AUTO)
222.42 - 224.02	WR6ADW	VENTURA, SULPHUR MTN	OPEN
222.44 - 224.04	WR6APS	LA CANADA, JPL	OPEN (WR6AZN LINK)+-
222.46 - 224.06	WR6AJL	LAGUNA MTN	IN OPERATION SOON - I
222.50 - 224.10	WR6AHX	SANTA ANA	OPEN
222.52 - 224.12	K6MHE Δ	MONTEBELLO	OPEN
222.54 - 224.14	WR6ANI Δ	LONG BEACH	OPEN - MOVING TO 223.80
222.58 - 224.18	WR6BBU	CHINO	OPEN
" "	K6GXD	PALMDALE	OPEN
222.60 - 224.20	WR6ACF	SAN DIEGO, MT. OTAY	OPEN
222.62 - 224.22	W6HIL	LONG BEACH	OPEN
222.68 - 224.28	W6NUI	PALOS VERDES	OPEN**WESTLINK T/TH 8 PM
222.70 - 224.30	WR6ABR	EAST LOS ANGELES	OPEN - L.A. RACES
222.78 - 224.38	WR6AVQ	PALOS VERDES	OPEN
222.82 - 224.42	WR6AAA	CATALINA ISLAND	OPEN
222.84 - 224.44	WR6AOY	MONTEREY PARK/SOUTH PASADENA	OPEN
222.86 - 224.46	WR6AKY	SAN DIEGO, PT. LOMA	OPEN
222.90 - 224.50	WR6ACB	ANAHEIM	OPEN
222.94 - 224.54	WR6AID	SAN DIEGO	OPEN
222.96 - 224.56	WR6AUJ	RUNNING SPRINGS	OPEN (CLOSED-AUTO)
222.98 - 224.58	WA6VNV	CHATSWORTH, OAT MT.	OPEN (CLOSED-AUTO)
223.00 - 224.60		REPEATER TESTING CHANNEL	NOT ASSIGNED
223.02 - 224.62	WR6ADL	HAWTHORNE	OPEN
223.04 - 224.64	WB6TAM	NORTH RIDGE	OPEN
223.06 - 224.66	WR6AIZ	LEMON HEIGHTS (ORANGE COUNTY)	OPEN (CLOSED-AUTO)
223.10 - 224.70	WR6AYI	LAGUNA BEACH, TEMPLE HILLS	OPEN - RTTY/VOICE
223.14 - 224.74	WR6ABJ	LOS ANGELES, HOLLYWOOD HILLS	OPEN
223.16 - 224.76	WR6AUT	TUSTIN, PEACOCK HILL	OPEN
223.22 - 224.82	WB6CYA Δ	SAN DIEGO, MT. OTAY	RTTY ONLY OPEN
223.26 - 224.86	WR6ACJ	CRESTLINE	OPEN
223.30 - 224.90	WD6HFR	SAN DIEGO, MT. PALOMAR	OPEN 220 CLUB SAN DIEGO
" "	WB6RHQ	THOUSAND OAKS	OPEN
223.34 - 224.94	WR6AJI	MT. WILSON	OPEN
223.36 - 224.96	WR6AYY	LOS ANGELES	OPEN (CLOSED-AUTO)

Δ NOT COORDINATED BY SPECTRUM MANAGEMENT ASSOC (TWO-TWENTY)

Above listings from a list furnished by J. Steve Cullings, W6XT, with permission to publish.

A complete list of 220 MHZ Repeaters in Southern California showing both Open and Closed repeaters may be obtained from W6XT by sending 5¢ and a stamped-self-addressed envelope to the address below. Lists are updated monthly. Send to J. Steve Cullings, W6XT, 3185 Alta Laguna, Laguna Beach, California 92651.

* NEW MEMBERS . . .

WA AED	Reuben V. Vaughan	1041 Leroy Street	San Diego,	92106	0180
KA6DER	Mike Kakiuchi	2925 House Road	Imperial	92251	0180
W6DWE	Claude L. Kirkpatrick	1744 Pacific Beach Dr.	San Diego	92109	0280 A
WD6EXN	Gene Lang	6546 Wandermere Drive	San Diego	92120	0180 A
N6HV	R. B. Pappenfort, MD	P.O.Box 10062	Rancho Santa Fe	92067	756-2973 0180 A
XE2IC	David Horta Mendez	Hermosillo 24	Tijuana BC Mexico	5-9373	0180
WA6IOP	Frank W. Dytrich	7567 Melotte	San Diego	92119	0180
XE2KA	Raul Gonzales Hernandez	Calle 3rd # 2048	Tijuana BC Mexico	6-33-64	0180
WB6NUF	Drexel D. Axsom	2146 Lincoln Street	San Diego	92104	295-2302 0180
W4NYU	Howard W. Gates	191 No. Mollison # 21	El Cajon	92021	447-5482 0180 A
W60ED	Eugene B. Etchells	2086 Willis Road	El Cajon	92020	0280
WB60XM	John E. Laird	10511 Greenford Dr.	San Diego	92126	0280 A

We wish to extend a hearty WELCOME to each of our new members who have recently joined Sandra. We are planning to publish a new membership roster which will include all new members and renewals as of the month of publication. Please be sure to check your name and address as it appears on the mailing label of this issue of Squelch Tales so that any errors in the listing can be corrected before the computerized run of the membership list for publishing it as the Sandra roster. Send any corrections in to the Membership Chairman, Vance Belliston, WA6KHA, (Attention of:), Sandra, P.O. Box 82958, San Diego, CA 92138. Corrections can also be made by calling in to 286-8550.

Fairmount Electronics

3721 FAIRMOUNT AVENUE, SAN DIEGO, CA 92105

714-282-8910

Got - 2 MTR SWR - PROBLEMS? Forget em! SOLVE Them
 Get the most out of your rig - Get a Leader LAC-897 ANTENNA COUPLER
 IT'S A COMBINATION - COUPLER - POWER METER - SWR METER
 Reads 5 watt - 20 w - 100 watt in three ranges - ONLY - \$69.95!
 Seen the new COMTRONIX 80 CHANNEL - 10 METER FM?
 IT'S - Terrific! - See IT Here!

N6AQU - ED

WE BUY - SELL - TRADE - HAM GEAR - CONSIGNMENTS ACCEPTED. LET US GET THE BEST PRICE FOR YOU!

WE HANDLE A NEW 2 METER "PAL" FIRESTICK ANTENNA, BASE AND MOBILE. THEY ARE MADE OF FIBERGLASS - FANTASTIC RANGE! SEE THEM HERE. (HAM LICENSE REQUIRED FOR XCVR SALES.)

OFFICERS:

President
 W6PDA Wayne Bamford 277-8320

Vice President
 NGLY Larry Harvey 224-5647

Secretary
 WB6NEH Esther Lizardi 271-7859

Treasurer
 W6QR Gil Severns 224-7253

Membership
 W6GKA Vance Belliston 464-2012

Meetings
 W6MDD Richard Dahl 767-5687

M.A.L.
 XE210 Alex Hodoyan 386-4233

M.A.L.
 WB6AMT Tony Lizardi 271-7859

M.A.L.
 W6PYO Marvin Brown 465-9002

TRUSTEES:

220, 450 &
 04/64 W6YVX Ed Flinn
 75/15 W6PDA Wayne Bamford
 285/885 K6QL Dave Fender



SQUELCH TALES is published monthly by the San Diego Repeater Association (SANDRA, Inc.), a non-profit corporation dedicated to the promotion of Amateur Radio. Distribution is free to members of the organization; subscriptions are available to others. News views and information exchanges (particularly newsletter exchanges with other clubs) are desired and solicited. The right to edit material submitted with respect to format, suitability, and style is reserved. Decisions are final.

Advertisements are \$30 per page, \$15 per half page, and \$7.50 for a quarter page or business card ad. Artwork or layouts should be submitted to reach the Editor, P.O. Box 82958, San Diego, CA 92138, by the first of the month in which the ad is to appear. Assistance in preparation of artwork and layout is available at no charge to advertisers desiring this service, although a longer lead time is necessary. Contact the Editor for specific requirements. Advertisements prepared by the SQUELCH TALES staff remain the property of SQUELCH TALES and may not be used elsewhere without written permission. Liability for errors in copy or other matter is limited to the printing of a correction in the subsequent issue.

Permission is hereby granted to reprint items from this issue of SQUELCH TALES in other Amateur Radio oriented publications provided credit is given to SQUELCH TALES and, when appearing, the author. Articles are only accepted on this condition unless otherwise noted. No liability is assumed for accuracy or originality of material. Opinions expressed unless specifically noted, are not necessarily the position of the organization, Editorial Staff, or Board of Directors of SANDRA, Inc.

SUNDAY EVENING
 MONDAY EVENING
 WEEKS WITH 04/04 & 10/10
 -AIR " NITE (SCHEDULE TO BE ANN.
 WEDNESDAY EVENING AT 7:30 P.M. ON 75/15
 - 0 -

INFORMATION & INTERFERENCE REPORTING:
 TELEPHONE NUMBER (714) 286-8550

SANDRA GUIDELINES

SANDRA, Inc. operates the following repeaters for service to the San Diego area and environs. The policy of the organization is that the repeaters are available for all licensed Amateurs to use, so long as applicable rules and regulations are observed, whether members of SANDRA, Inc. or not. Further, the following priorities must be observed: (1) Emergency traffic, concerning the safety of life or property take priority over all other traffic. Failure to yield to any station indicating the need for such traffic is prohibited, and may render the offender subject to legal action. Indication of the need for such traffic may be "Break Emergency," "Break-Break," or any other clearly indicated statement. (2) Call-ups should be permitted. If an operator "breaks" into a conversation, he should be permitted to make such a callup. He should not, however, "take over" the repeater and exclude those who were already using it. (3) "Rag-chewing" is not prohibited, but care must be exercised to assure that the repeater is not tied up for extended periods. Remember, there are almost 400 members, and several hundred non-members, who have as much right to use the facilities as you do. It is extremely discourteous to monopolize them to the exclusion of these other users. Long QSO's should be limited to simplex frequencies or the lower bands.

SANDRA REPEATERS

		IN	OUT
WR6ACF	Otay	222.60	224.20
WR6ACF	Otay	146.040	146.640
WR6ACF	Otay	*444.50	449.500
		*1-B PL reed	
WR6AJL	Laguna	147.750	147.150
WR6ASM	San Diego (Sharp Hospital)	147.285	147.885

Member of ARRL?

YES NO



Yes, I would like to become a member of SANDRA.

Full Membership: \$10 Initiation (one-time)
 \$10 Membership
 \$20 Total

Limited Membership: \$12 per year

(Only for those who live outside of the San Diego area. Voting privileges are not included.)
\$ 3 for badge, plus 50* for mailing

Amount Enclosed \$ _____ Date _____ Signature _____

NAME _____ CALL _____

ADDRESS _____ PHONE _____

CITY _____ STATE _____ ZIP _____

Mail to SANDRA, Inc., Post Office Box 82958, San Diego, Ca., 92138

SANDRA, Inc.

San Diego Repeater Association

P. O. Box 82958

San Diego, CA 92138



BULK RATE
U. S. Postage
PAID
SAN DIEGO
CA.
PERMIT
1520

Coming Events . . .

- FEB. 14 GENERAL MEMBERSHIP MEETING AT BONANZA RESTAURANT AT 2633 EL CAJON BLVD - 7:30 PM
- FEB. 17 T-HUNT STARTING AT DEL CERRO AT 7:30 PM
CHUCK WOOD, WDGAPP WILL BE HIDING. ALL HAMS ARE INVITED TO JOIN BY MOBILE OR BY DF-ING FROM THE HOME QTH.
- FEB. 22 SANDARC MEETING AT 3650 FIFTH AVENUE AT 7:30 PM. MEETING IS OPEN TO ALL PARTIES.
- MAR. 1 BOARD OF DIRECTORS MEETING AT THE EL CAJON BONANZA RESTAURANT, 7:30 PM.
- EVERY SATURDAY - HAM BREAKFAST MEETS - CHOICE OF 2:
BOB'S BIG BOY RESTAURANT, 2 BLOX EAST OF CLAIREMONT MESA BOULEVARD (EAST OF HWY 163)
COCO'S FAMOUS HAMBURGERS AT 5505 LAKE MURRAY BOULEVARD IN LA MESA.
BOTH HAM BREAKFAST MEETS START ABOUT 9 AM.
ALL HAMS, OMS, YLS, AND FRIENDS - WELCOME!

