

# SQUELCH TALES

SAN DIEGO REPEATER ASSOCIATION

VOLUME X

APRIL 1982

NUMBER 4

## WD6EBW UNVEILED!

This month SQUELCH TALES takes a trip to West Los Angeles and visits the inner sanctum of WD6EBW, "Extra Big Walter". Is all this stuff he tells us on 04/64 true? Did he really know Amelia Earhart? Or did he just dream it up? Read on in our lead article.



What's going on here? That's Walter, WD6EBW, on left. Fred, N6CTX, innocently stands by as Phil, W6MRQ attacks with a nine iron. Phil failed in his attempt to get Walter to use his call sign instead of "Break". Famous scrapbook is in the foreground, and the back wall is full of Amelia Earhart memorabilia.

### ALSO IN THIS ISSUE

- o A SPECIAL - Pages from V. P. Pettybone's Notebook surface in Cal's Corner
- o HIGH WATER - Hams perform as eyes and ears for city agencies during heavy rains
- o PORTABLE ANTENNA MAST - A unique construction project by SANDRA member KA6IAS
- o AND MUCH MORE .....

# the computer merchant

**WE ARE SAN DIEGO'S LARGEST  
EXCLUSIVELY APPLE DEALER**

**AS YOUR FULL SUPPORT DEALER,  
WE OFFER YOU...**

- CUSTOM-TAILORED SOLUTIONS
- IN-STORE SYSTEM CHECKOUT
- INTRODUCTORY INSTALLATION  
INSTRUCTION
- AFTER-PURCHASE SUPPORT  
& INSTRUCTION
- QUICK SERVICE FROM OUR  
MODEL SERVICE DEPT.



**The  
Computer Merchant**  
5107 El Cajon Blvd  
San Diego, CA 92115  
583-3963

**The  
Computer Merchant**  
1040 East Valley Parkway  
Escondido, CA 92025  
746-0662

**"A Smart Way to Buy Apples"**

**apple computer**

\* Authorized Dealer and Service Center  
YOUR FULL SUPPORT DEALER

**HOURS Monday - Saturday 10-6**

**SINCE 1978**

## A PART OF HISTORY

You hear an awful lot of stuff on the ham bands.

It is one thing to tune to a popular two meter repeater frequency and hear fishermen discuss their prowess. It's logical that technicians brag of their radio skills. It follows that there are experts on weather prognostication and traffic direction. And every good repeater has someone dialing the CHP even before the accident happens. However - it is something else when some turkey comes up and says "I was the guy who held Amelia Earhart's hand when she made the first woman's solo flight over the Pacific Ocean".

As if 146.047.64 does not have enough problems.

This fellow, WD6EBW, Walter McMenamy, up in West Los Angeles, starting feeding this malarky on our Otay repeater over a year ago. A secret committee was formed, and judgement was passed: "There is no truth in him".

There was no choice but to expose him. Two SQUELCH TALES staffers were dispatched to Los Angeles, and with the aid of a prominent Hollywood ham who is always seeking the truth, Walter was exposed.

The record shows: WD6EBW was born in St. Louis, Missouri, on August 8, 1905. He was an incubator baby, and led a tragic life, much in hospitals, until he was 20 years old. But he ate well. He had grown to six feet, eleven inches in height. In the early 20's, Walter became interested in radio and built galena crystal and simple tube sets for sale. And he became a Short Wave Listener nut.

By the 1930's, he was logging worldwide broadcast signals and distributing Patterson Radios, whose fine receivers were designed by Karl Pierson, W6BGH.

And now the truth.

Amelia Earhart was an American aviator. She was the first woman to cross the Atlantic. She was also the first woman to make a trans-Atlantic flight alone. In 1935, she set out to become the first woman to make a solo flight across the Pacific Ocean, from Hawaii to the mainland. Conditions established were that continuous radio contact be maintained.

The scheme was this: She would transmit from her airplane on 3105 kilocycles, call sign KHABQ, and receive on clear channel KFI from

Los Angeles, whose 50,000 watts on 640 kilocycles would blanket the Pacific during the night time hours of the early part of the flight. Problem that developed was that no one could hear her signals in the States, until Walter came on the scene. While tuning for dx signals, he heard Amelia's test transmissions and caught on to the scheme. He contacted KFI and became a primary link for the flight. To quote from a letter from the Program Director of KFI, dated January 18, 1935, six days after the flight, "Miss Earhart's messages received by you were telephoned to KFI and were immediately broadcast over KFI's 50,000 watts for the information of radio listeners in general, and for Miss Earhart's information in particular..... were a source of great comfort and assistance to her".



• WD6EBW and Amelia Earhart face the Press after her historic solo flight from Hawaii to Oakland, California, January 11-12, 1935

(Continued on Page 3)

# JIMMY'S

## FAMILY OF FINE RESTURANTS

"Exclusive but not expensive"

9635 MISSION GORGE ROAD, SANTEE

COME IN FOR BREAKFAST AFTER THE SWAP MEET

OWNERS

GEORGE GIFOROS

NICK PAPPAS

(714) 448-8994

## SPECIAL OFFER

KD6QB, Bill Callier, and his wife June are making an exceptional offer to SANDRA members. At their cost for materials, there are a limited number of the blue and white SANDRA name badges available. This is the one that always stands out!

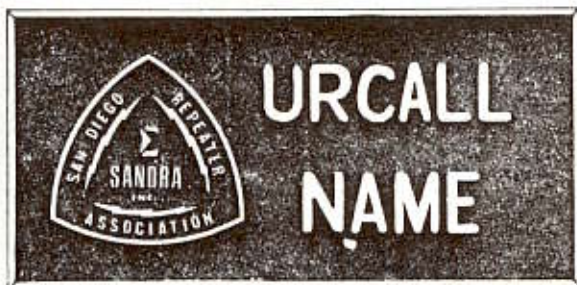

\$3.18 including tax  
Callier Enterprises  
342 N. Meadowbrook Drive  
San Diego, CA 92114  
Phone 460-4754

### ACTUAL SIZE

Two Inches By Four Inches

Ever come away from an Amateur Radio meet with a severe case of eyestrain and still not be sure who it was you had been talking to? Be kind to others - wear one!

(Continued from Page 1)

Union Air Terminal  
Curbank, California  
March 4, 1937

Dear Mr. McMenamy:

It is pleasant that you are helping me with radio communication matters again on my forth-coming flight. I so much appreciated your work and cooperation on the Pacific hop in 1935. You were in contact with me from the time I left Honolulu until I came down to Oakland.

Let's hope we have as good luck this time.

Very truly yours,

In 1937, Amelia and her co-pilot Fred Noonan set off on a flight around the world. Walter was a key participant in the radio links for the flight. See our copies of letters from Amelia and her husband, book publisher George Palmer Putnam, who financed the flight. Official reports state that her last signals were heard on July 2, 1937, and that her plane was lost in the Pacific while trying to reach Howland Island. Walter feels that there is much more to the story.

So there is WD6EBW unveiled. Our hats off to you, Walter, for being a part of history! Our best to you and your charming wife Mary.

Oakland Airport  
Oakland, California  
March 11, 1937

Mr. W. B. McMenamy  
Guy H. Dennis  
Station 783CB  
1130 Greenwood  
Los Angeles, California

Gentlemen:

On behalf of Miss Earnest, I want to thank you for the helpful assistance given us in Los Angeles in connection with flight preparations.

We are much interested in your plans for keeping in touch with her, and feel such cooperation may be of very real value. So far as possible, I know Miss Earnest will cooperate with you.

Yours very truly,

  
George Palmer Putnam

## CLASSIFIED ADS

• FOR SALE Six meter transmitter. Portable. 2½ watts. 6 crystals transmit. Layfayette Model HA-650. \$100 or offer

Two meter handi-talkie. 1.6 watts, 2 channel. Uses standard AA Nicads, 10 supplied. Crystals for T6.04 - R6.64, T6.8 - R6.2, T6.34 - R6.94, T6.94. Varitronics HT-2. \$100 or offer

Daro, WA6ZMQ, 292-5210

• FOR SALE TEMPO S-1 handi-talkie. 12 button TT pad, rubber ducky and telescopic spike, Motorola belt clip, extra Nicad battery pack, wall charger and earphone.

Complete \$150

Larry, WA6PLX, 286-2829

• FOR SALE YAESU FT-227R Memorizer. \$175

Paul, WA6EEH, 264-6480

• FOR SALE MFJ audio filter unit. For SSB/AM/CW. Brand new, still in box. \$70

Jerry, WD6GIW, 223-1004

• FOR SALE ICOM 230 with splits. \$145

WANTED CW keyboard.

(9 AM to 1 PM only)Lenny, WB6SIP, 582-9182

• FOR SALE TEMPO FMI. Crystals: Simplex .94, .52, .76, plus Laguna, Otag, Catalina Island. Case, rubber duckie, charger, 110V Hi/Lo, spare crystals - Palomar .13/.73. \$120

After 5 PM and week-ends WB6BCT, 569-8741

• FOR SALE Kenwood TR2400A with touch tone mike and Larsen antenna. (From estate of WA6QXP). \$225

Dave, K6QL, 748-9661

Dave, K6QL, 748-9661

• FOR SALE Yaesu 207R, 2M HT with manual, charger and spare battery. \$150

Gene, W6OED, 447-5014

• WANTED Bird wattmeter, with or without functioning meter movement.

Larry, WA6AIL, 277-6352



Glenn Rattmann K6NA

Tom McDuffie KM6K

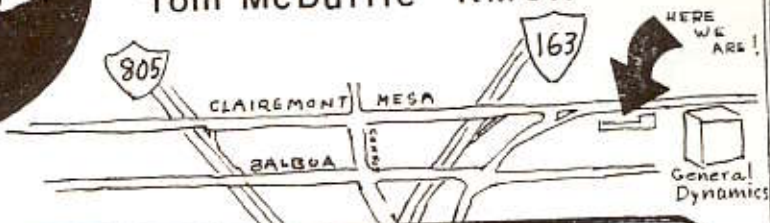

# LOOK! SPECIALS!

KENWOOD TR-2500 2M HT .....	SPECIAL PRICE
YAESU FT-208R 2M HT .....	SPECIAL PRICE
KENWOOD TR-7730 .....	PRICE TOO LOW TO PRINT!
KENWOOD TR-7850 (50W OUT) .....	\$389.95
YAESU FT-707 HF TRANCEIVER <u>SPECIAL</u> .....	\$699.95
KENWOOD TS-830-S .....	\$839.95

----- BETTER THAN NORMAL DISCOUNTING  
KENWOOD "BONUS BUCKS PROGRAM" IN EFFECT - CALL THE STORE

ROBOT 400 (SSTV) AND 800 (CW/RTTY KEYBOARD) ON DISPLAY  
ASK ABOUT THE ROBOT REBATE PROGRAM

LARGE STOCK OF ANTENNAS, ALL MAJOR BRANDS  
UPGRADE NOW FOR SPRING DX SEASON!

WE STOCK TONE ENCODERS FOR MOBILES/HT'S  
COME IN, BROWSE AROUND, AND SEE OUR GEAR!

(THE FT-ONE IS HERE!)

5375 Kearny Villa Rd., San Diego

560-4900

STORE HOURS: 10 AM TO 5:30 PM. CLOSED SUNDAY.

# MEMBERSHIP MEETING

Minutes of the General Membership Meeting - March 18, 1982

The regular membership meeting for March took place on the above date at the Educational Center on Linda Vista Road. Upon a quorum being present, the following business was conducted:

1. The minutes of the February 18, 1982 meeting were approved as they appeared in Squelch Tales.
2. K6BWT presented the by-laws amendment the effect of which is to prohibit a member from holding more than one office on the Board of Directors. WB7SPD moved approval, which was seconded by W6GVK. The amendment carried unanimously.
3. Announcements
  - a) N6FUY announced the T-hunt to be held March 20. An all-YL team of rabbits will be hiding. A T-hunter was overheard to remark that he had been chasing women for years but this would be the first time he'd used a radio.
  - b) K8WEN is accepting volunteers to be net control for the Sunday night net on 04/64. Interested parties should contact Jack and he will schedule you for one or more Sundays.
  - c) W6PDA commented briefly on the state of repairs on the Laguna repeaters.
4. AF6W moved to amend the recommended operating procedures to provide that a station wishing to break on the repeater do so by giving his callsign or the callsign and nature of his call. The motion was seconded by WB6TIQ. After discussion, the motion passed unanimously.
5. The program was presented by Pacific Telephone's Terry Hovland.
6. WA6JTB moved that AF6W be Sheriff of Sandra. The motion was seconded by KM6S. After discussion, the motion passed, W6OGC voting no.
7. WD6DNW moved to adjourn, which was seconded by the guy in the blue hat, and passed unanimously.

## SIGNED IN

WB6WHM	WD6APP	KA6ILV	WB6NGP	N6FUY	KF6Z
K8WEN	WD6CQM	WB6IKF	K6BWT	W6UZZ	AF6W
N6FWQ	W6GIC	WA6QVW	WB7SPD	WB6POW	WA6SPF
KA6QED	KA6QPH	WB6TIQ	WA6JTB	WA6ZMQ	W6MVV
WB6SHF	WA6OYI	WB6YHC	KA6MKW	AJ6L	KM6S
W6INI	WD6DNW	N6FHZ	WB6OHH	WB6CDK	K6EVM
WD6FUP	WD6FUN	WA6KPA	KA6IAS	W6GVK	WD6CWZ
N6AQU	W6PDA	WB6SYD	W6OGC	N6AVR	W6SLF
W6IZS	NANCY	N6ECL	DULJEC	WA6BCC	CHARLES
		WA6AIL	K6BWT		



James M. Allen, W6OGC  
Secretary

SINCE 1945

# SHANKS & WRIGHT

## ELECTRONIC SUPPLIES

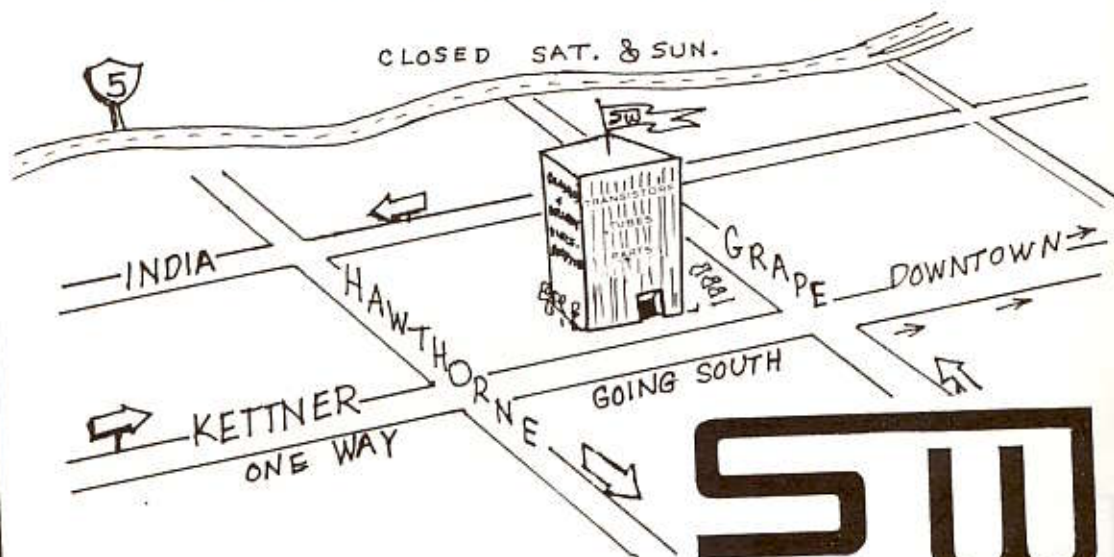

Dick  
W6BZE

2045 Kettner Blvd.  
San Diego CA 92138

239-0176

Si  
W6OSD



# BOARD MEETING

SANDRA, INC.  
Board of Directors

The regular monthly meeting of the Board of Directors was called to order on April 1, 1982, at 7:30 P.M. at the Bonanza Resturant, 2633 El Cajon Blvd.

Directors present: W6OGC, K8WEN, W6U2L, WA6JTB, WB6IKF, W6GIC, W6PDA.

Visitors present: N6ECL, AJ6L, AF6W, WD6CQM, W6INI.

1. W6OGC reported on the status of the club's insurance.

2. W6OGC reported on the status of the Mt. Otay site. A map is being prepared by the engineer to show "as-built" and will be submitted shortly. It was recommended that the bond premium be paid, if it has not already been paid. It was also recommended that a meeting of the board be held to consider policies for other repeaters at the SANDRA site.

3. Treasurer's report was deferred as the Treasurer was out of town.

4. W6GIC reported that we have 13 new members and 34 renewals, bring the total membership to 971, with 924 voting members.

5. Meeting Chairman, WB6IKF, reported that Bob Rubesh, Robot Research, will put on the program for our April Membership Meeting.

6. W6U2L reported on SANDARC activities. During his report, W6OGC moved and W6PDA seconded a motion to approve SANDARC's funding of a scholarship in the amount of \$300. The motion was passed unanimously.

7. W6OGC moved that the SANDRA delegate to SANDARC prepare a proposal that SANDARC reimburse Emergency Coordinators in San Diego County for administrative expenses, in sum not to exceed \$500 per year. The fund would be administered by the Section Emergency Coordinator. The motion was seconded by WA6JTB and passed unanimously.

8. Trustees report. W6PDA reported on Laguna. The ID'er is malfunctioning. Expects to have it fixed shortly. He plans to install the new 450 and 2 meter antennas as soon as weather permits. Nothing new to report in the move to the new building.

9. Technical Committee Chairman, AJ6L, submitted a candidate list for members of the technical committee for consideration by the Board. W6GIC moved, seconded by W6OGC, that they be approved. Passed unanimously. Members are: AJ6L, Tom Wilson, Chairman; W6PDA, Wayne Bamford, K6QL, Dave Fender, W6SS, Vance Belliston, and W6YVX, Ed Flinn, our four trustees; N7BDO, Rich Bennett, N6ECL, Stu Hacken, WA6QQQ, Bob Gonsett, K8WEN, Jack Carlson, and KF6Z, Tom Goldrich.

10. W6U2L reported that Les, WA6QVW, had a prior commitment and would present his Property Manager's report at the next Board meeting.

11. K8WEN reported to the Board on the Sunday nite net control. Members who wish to assume the net control for one or more Sunday evenings should contact him via the SANDRA P.O. Box or his home telephone number.

12. The following matters were discussed without action: AF6W proposed a secret society of SANDRA members to encourage improved operating habits on the repeaters. W6U2L raised the issue of hi-way signs giving repeater frequencies to visitors arriving in San Diego County. W6PDA discussed a proposal to provide the autopatch with a means for emergency activation when the autopatch function is off. WA6JTB is going to contact the roofing contractor in regard to the roof on the Mt. Otay vault. AF6W discussed the need for member health and welfare announcements at membership meetings. It was noted that it is the policy of the club to send "get well" cards to members who are ill.

13. WB6IKF moved, and W6JTB seconded, a motion to adjourn, which passed unanimously at 9:34 P.M.



James M. Allen, Secretary

## SILENT KEY

Johnny Johnston, W6KBT, passed away on April 2, 1982. Johnny was a stalwart sentinel on the 147.75/.15 SANDRA repeater for many years, always ready with a helping hand. He was loved by all his fellow hams.

# ICOM IC-730

ICOM's Go Anywhere HF Rig for Everyone's Pocketbook



## Compact.

Only 3.7 in (H) x 9.5 in (W) x 10.8 in (D) will fit into most mobile operations (compact car, airplane, boat, or suitcase)

## Affordable.

Priced right to meet your budget as your main HF rig or as a second rig for mobile/portable operation.

## Convenient.

- Unique tuning speed selection for quick and precise QSY, choice of 1 KHz, 100 Hz or 10 Hz tuning.
- Electronic dial lock, deactivates tuning knob for lock on, stay on frequency operation.
- One memory per band, for storage of your favorite frequency on each band.
- Dual VFO system built in standard at no extra cost.

## Full Featured.

- 200W PEP input—powerful punch on SSB/CW (40 W out on AM)
- Receiver preamp built-in • VOX built-in
- Noise blanker (selectable time constant) standard
- Large RIT knob for easy mobile operation
- Amateur band coverage 10-80M including the new WARC bands
- Speech processor—built-in, standard (no extra cost)
- IF shift slide tuning standard (pass band tuning optional)
- Fully solid state for lower current drain
- Automatic protection circuit for finals under high SWR conditions
- Digital readout • Receives WWV • Selectable AGC
- Up/down tuning from optional microphone
- Handheld microphone standard (no extra cost)
- Optional mobile mount available

In stock: ASTRO 150 ICOM 22U ICOM 260A SWAN 100MX TEMPO 35 CDE ROTATORS  
 ASTRO 102EX ICOM 2AT ICOM 255A ICOM 720A TEMPO S1,S2 Visit or call now!!!

Mike, WB6IIK

1415 INDIA ST. 92101

WESTERN RADIO  
 ELECTRONICS

SAN DIEGO 714 239 0361

Paul, XE2XV

8:30 to 5:00 Monday thru Friday

## FLOOD WATCH

A headline in the Los Angeles Times on Friday, March 19, was "San Diego Drying Out After Heaviest Rainfall of Winter". The storm ripped the roof from a Loma Portal house, left 20,000 households temporarily without power, tore a dozen boats from their moorings in San Diego bay, flooded roads and stranded motorists. And the water was rising in City reservoirs and rivers.

Local amateur radio operators played a key role in this near emergency as volunteers with the San Diego City Emergency Management Office. Approximately 50 hams have now completed initial training in emergency management and are now registered with this office.



- Barbara Cavoulas, Office of Emergency Management, and Wm. N. (Buck) Miller, N6BLK, man the phones and ham radio during the height of the winter storm.

Wednesday, March 17, was the first real test of "Flood Watch" by hams who patrolled flood markers on the San Diego river, and Chollas and Carter creeks. That's where the water goes when we have a local gully washer.

Working the Flood Center at the desk of the City's Coordinator for Emergency Management, Bill Wulf, were KD6QJ, KM6S, N6BOK and W6UZZ, working shifts. In the field were WA6LWL, W6FWF, K6DBJ, W6QLJ, W6BFQ, KR6K, K6QM, WB6TOH, KA6JEH, WA7HRA, W6LEY, WB6RJB, N6CUX, WA6BCC, NE6T, WA4SHIP, KA6IAS, and WB6LLO. W6INI coordinated team and route assignments.

In addition to specific assignments for flood marker checks, the teams provided reports on road closures, stranded motorists, and in general provided extra eyes for regular city employees who were combatting the storm.

Water levels in local reservoirs were recorded periodically at the center. Phones rang constantly with requests for information by citizens, and newspaper, radio and television reporters.

Bill Wulf says he is looking for more volunteers. A phone call to Art Smith, W6INI, at 273-1120 will put you in touch with him.

## CONVAIR CLUB

The Convair Radio Club had election of officers on March 4, with installation dinner April 1.

New President is KM6S, Joan Samuels; Vice-President, N6FNQ, Dick Gillson; Treasurer, N6AFB, Bob Squire; Secretary, K6DBJ, Nick Callas; Station Engineer and Commissioner, K6DVH, Bill Roden.

Joan says that the club is open for anyone to join as associate members, and if you don't care to become a member, you are welcome to drop in for a visit. The club offers picnics, pot luck, novice classes and opportunities to upgrade. Interesting programs and short business meetings.

May 16 will be the second annual Amateur Radio Emergency Service (ARES) picnic, to be held at Convair Missile Park and hosted by the Convair radio club. Hopefully the 1945 REO truck, command post communications system from the City of Coronado, will be there, and if everything goes well, this will be the premier of the San Diego Police Department's command post vehicle.

## FELLOWSHIP

Two non-club oriented get-togethers of hams are coming up this month.

Friday, April 16 There will be a ham meet at the Organ Power Pizza, Imperial Avenue at Broadway in Lemon Grove. Come one, come all. Wear your badge and show between 6 and 7 PM. CU there. K6OBP

Sunday, April 25 The first W6LNB/WD6DSV event of the season. El Monte Park, near Lakeside. 12:00 noon. Bring a dish to pass, and your own meat course. Grills available. Talk in on 146.52. Lee WB6JPX

# World's No. 1 YAESU Specialist

Home of the ONE-YEAR warranty

(Wholesale cost of parts charged after 90 days)

## Best price, best warranty, fast service

As some special items have a limited warranty, all invoices must be presented for warranty work.

Culver City Store Hours Mon-Sat 9-6; Tues 9-8



YAESU FT-902DM  
**\$1295**

CUBIC Astro 103



Dual PTO's Synthesized  
1.6-30 MHz 235 Watts PEP  
**\$1195**

DAIWA J.W. MILLER



Automatic Antenna Tuners!  
Call or write for SUPER LOW prices!



MIRAGE amplifier NAV  
**\$179.95**

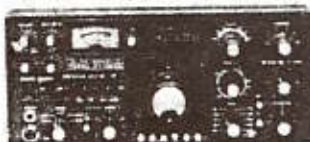

FT-1012D (WARC) 9-band digital III FM  
**\$795**



FT-127RA 220 MHz Reg. \$479  
**SALE \$425**



J.W. MILLER AT-2500  
**\$698**



FT-107M (WARC) 9-band Dig. xcvr  
**\$949**



CLIPPERTON L. List Price \$749  
OUR PRICE **\$659**

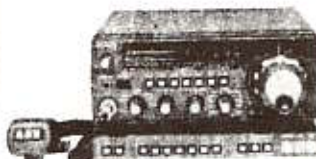

FT-707 8-band, 3.5-30 MHz digital xcvr  
**\$695**



AZDEN **\$335**

FT-720 RVH  
2 METER RIGS  
\$269  
GET ON 450 Mhz  
CHEAP  
FT-720 RU  
\$289  
OR USE ON BOTH  
BANDS FOR \$478



SANTEC HT-1200  
Reg. \$379  
**SALE \$299**  
ST-7T 450 MHz  
**SALE \$309**



BIRD Wattmeter  
**\$142**



LUNAR **\$179**



AEA MORSEMATIC  
**\$179**

## JUN'S ELECTRONICS

3919 Sepulveda Blvd.  
Culver City, CA 90230  
(213) 390-8003

7352 University Ave.  
La Mesa, CA 92041  
(714) 463-1886

Sales Manager: THURMAN BEACH, W600X

# NEW MEMBERS

## NEW MEMBERS IN MARCH

WA6BY	BRUCE SCHOLDS	BOX 6025	CHULA VISTA	92011	429-9300
WD6DUX	CHARLIE PARKER	2509 E. 1ST ST.	NATIONAL CITY	92054	267-9014
N6DY0	ROBERT CLARK	162 SHERRI LANE	OCEANSIDE	92054	439-7058
KM6EB	SAM KIBLER	10023 HIRAM WAY	LAKESIDE	92040	561-2675
KM6EC	MARILYN KIBLER	10023 HIRAM WAY	LAKESIDE	92040	561-2675
N6FBZ	BARRY ELLIS	2839 DALE ST.	SAN DIEGO	92014	284-6930
N6FGG	BILLY GENE BRADLEY	640 11TH ST. APT G	IMPERIAL BEACH	92032	575-7280
N6FUT	DAVID THOMPSON	25704 SAN FILIPE RD.	WARNER SPRINGS	92086	782-3492
N6G3V	LUTHER CHRISTENSEN	6348 ELMCREST DR.	SAN DIEGO	92119	460-7970
WA6LDL	ROBERT KOLLEN	17457 OLIVE TREE CIR.	YORBA LINDA	92636	993-0451
W6SCS	WALTER CRUSBERG	2675 FLETCHER PKWY #323	EL CAJON	92020	461-3932
W6SDV	HARRY CURRY	4439 MUIR AVE.	SAN DIEGO	92107	224-5067
W6SHY	TOM PASTORE	6301 CASTEJON DR.	LA JOLLA	92037	571-2143
KA6TAW	VERNARD GRINOLDS	6776 WUNDERLIN AVE.	SAN DIEGO	92114	264-6312
WB9ULW	STEVE DARI	USS BERKELEY (DDS-15)	SAN FRANCISCO	96661	272-7088
W6WYN	ALFRED RICH	6970 FORUM ST.	SAN DIEGO	92111	278-2657

The Heathkit SA-5010  $\mu$ Matic™ Memory Keyer — best buy of its type in ham radio — has features so unique we've applied for a patent!



FAST, EASY  
2-EVENING KIT

\$99<sup>95</sup>

- Includes removable capacitive touch iambic paddles
- Up to 10 buffers are available for the storage of text or "command strings"
- Features a speed range of 1 to 99 words per minute
- Four-level random practice mode allows 6,400 different, repeatable practice sessions
- Rear panel jack allows use of a mechanical paddle with the SA-5010  $\mu$ Matic Memory Keyer
- Easy to build and easy to use, the Heathkit SA-5010 is your best value in a memory keyer

The  $\mu$ Matic Keyer's easy-to-learn keyboard

PRAC key for 6,400 practice sequences

RPT key repeats message from one to 10 times

WT key lets you change dot/dash/space ratio



"Tune" accesses auto tune mode

"SPCG" changes your character and word spacing

"WPM" sets both your load and send speeds

"P/C" programs pause, continue after inserting special text

## HAMONICS

de WB6QEZ



"I wonder if you could make your estimate a little more explicit than 'wow - this will set you back a few big ones'?"

TNX to THE CALL LETTER

SQUELCH TALES

WELCOMES

HEATHKIT

AND

GUY MORIN

TO OUR PAGES

**Heathkit**  
ELECTRONIC CENTER

Guy Morin  
Manager

Heathkit Electronic Center  
8363 Center Drive  
La Mesa, California 92041  
(714) 461-0110

## CARLS CORNER

One friend to another:

"I just got a brand new Cadillac for my wife."

Other friend:

"That's a pretty good trade!"

K6OBP

## TECHNICAL CORNER

This month we are pleased to feature the handi-work of an ingenious SANDRA member, Carl Tillman, KA6IAS. Using readily available materials, he has designed a portable mast suitable for two meter antennas. As shown in our accompanying photo a Larsen 5/8 magmount sits on the ground plane on top. The mast is also compatible with a Ringo Ranger or a small beam. Even could be used as the center support for a low band inverted V. This mast puts the base of your antenna 15 feet above ground, yet breaks down to the easily portable components shown. For assembly, Carl timed himself from car trunk to on-the-air in ten minutes!

Just the thing for your next picnic, camping trip, or ARES outing.

Carl designed the mast around standard collapsible tent poles, which can be found in the sporting goods departments of many stores. The only feature that will be beyond the reach of the average ham work bench will be the welded tripod joint. If you can't find a friend to do this little job for you, perhaps a drilled wooden block could substitute. He uses nylon cord for guying and 1/4" stainless steel welding rod for ground stakes.

So you can put "hands on" this handy device, Carl will demonstrate it on April 15 at our next SANDRA membership meeting.

## ELECTRONIC LOVE

If she wants a date .....	Meter
If she comes to call .....	Receiver
If she needs an escort .....	Conductor
If she's been cheating .....	Detector
If she's too fat .....	Condensor
If she's too thin .....	Feeder
If she's too extravagant .....	Limiter
If she's in error .....	Rectifier
If she fumes and fusses .....	Insulator
If her hands are cold .....	Heater
If she's ugly .....	Transformer
If she's bossy .....	Resistor
If she's bored .....	Exciter
If she refuses .....	Rejector

Wade WD6AOZ



# PORTABLE ANTENNA MAST

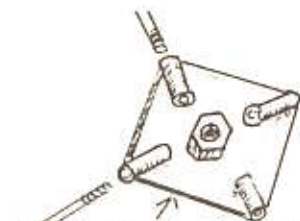
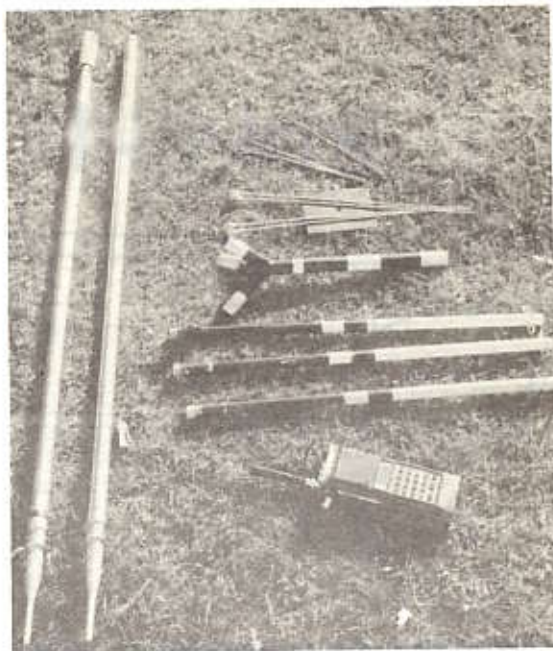
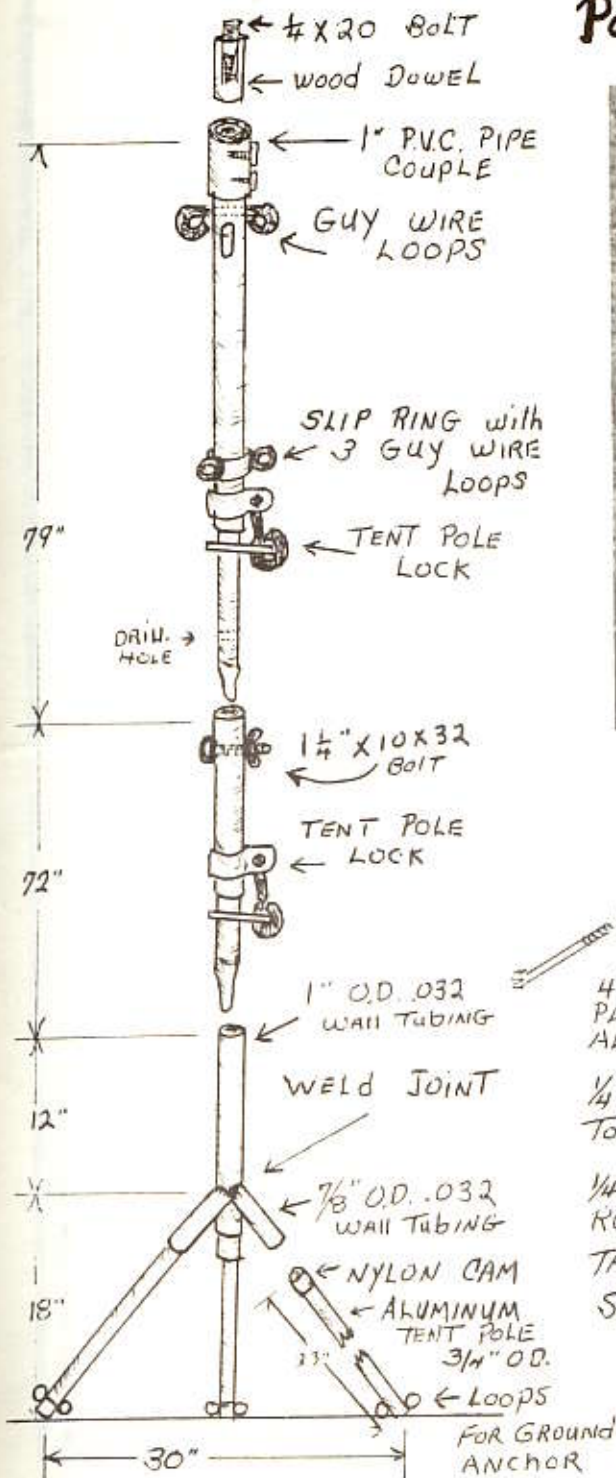

PORTABLE GROUND PLANE FOR MAG MOUNT ANTENNA

4" X 4" METAL PLATE - NOT ALUMINUM -  
 $\frac{1}{4}$ " NUT BRAZED TO CENTER -  
 $\frac{1}{4}$ " X 1" BRASS RODS DRILLED & TAPE 6 X 32 THREADS SOLDER TO CORNERS -  
 THREAD 4 BRASS OR ALUMINUM RODS - CUT TO PROPER GRD PLANE LENGTH -

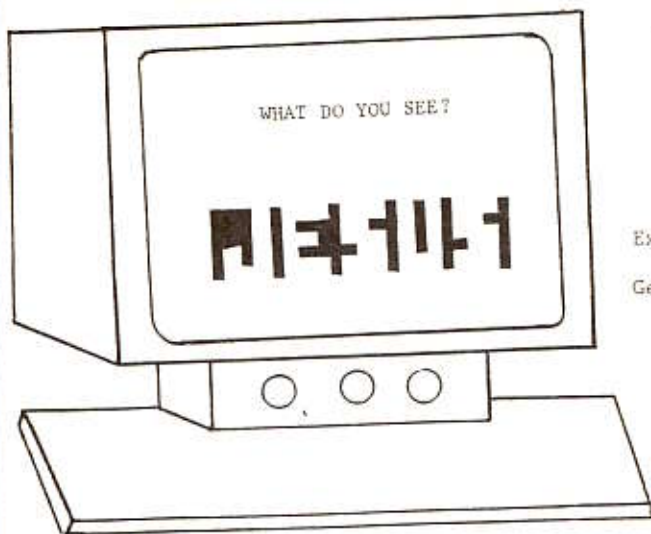

## THE TV SHOP

3126 UNIVERSITY AVENUE  
SAN DIEGO, CA 92104

Expert Service, Reasonable Rates

George Runyan/Color TV Specialist

Home Service by Appointment

**GEORGE - WB6YEC - OWNER**

**TELEPHONE**

**280-6023**

Also Dealing in Used AMATEUR Gear  
Equipment Sold on Consignment Basis

## INTEGRATED CIRCUITS UNLIMITED, INC.

7889 Clairemont Mesa Blvd.

San Diego, Calif. 92111

9:00 - 6:00 monday thru friday

278-4394

WE ARE PLEASED TO HELP SUPPORT THE SAN DIEGO REPEATER  
ASSOCIATION. WITH THIS CERTIFICATE, WE WILL BE  
PLEASED TO OFFER A 15% DISCOUNT ON REGULAR MERCHANDISE  
PURCHASED BY SANDRA MEMBERS.

YOUR CALLSIGN \_\_\_\_\_

SIGNATURE \_\_\_\_\_

OFFER EXPIRES APRIL 30, 1982



ADVERTISERS

# THIS SPACE FOR SALE

THIS WHOLE PAGE

\$30 PER MONTH

SQUELCH TALES GOES EACH MONTH TO OVER 900 ACTIVE RADIO AMATEURS IN SAN DIEGO COUNTY WHO ARE MEMBERS OF SANDRA. YOUR MESSAGE WILL REACH EACH OF THEM WITH A FULL PAGE AD FOR ONLY 3 1/3 CENTS PER MONTH

CAMERA READY COPY SHOULD BE 8½" x 11" FOR FULL PAGE. WE CAN HELP YOU WITH LAYOUT, ETC. CALL THE EDITOR, WALTER HICKS, AT 292-7918

OR THIS 1/2 PAGE

\$15 PER MONTH

OR THIS 1/4 PAGE

\$7.50 PER MONTH

OR, YOUR BUSINESS CARD

\$5 PER MONTH

## PROBLEMS OF THE MONTH

### MARCH ANSWERS

1. 8.8 milliamperes
2. (a) 1.81 Mhz. (b) 160 meter amateur band
3. 5%

### APRIL PROBLEMS

1. A 6V mobile receiver draws 36 watts. It is to operate from a 12V battery. What value resistor must be used in series with it to maintain the 36 watt receiver dissipation?

*1.5Ω  
2500Ω Resistor*

2. A 12.6 volt automobile battery is across a 1.5 ohm headlight lamp. If the battery has 0.14 ohm internal resistance, what is the current value? What is the loaded terminal voltage of the battery?

*7.48 AND  
11.52 VOLTS*

3. A 12.6 volt tube filament and a 6.3 volt, 0.3 amp tube filament with a series resistor are in parallel across 12.6 volts. What is the value of the required resistor?

*21Ω*

F. D. Buell, N6CTX

# SPEAKEASY PIZZA



361 NORTH MAGNOLIA  
FED MART SHOPPING CENTER

## PIZZA PASTA SANDWICHES

BANQUET ROOM AVAILABLE BY RESERVATION

HANS REUTER, KA6PNN

WE DELIVER

CALL 442-0906

EL CAJON

## SURPLUS ELECTRONICS

power supplies	pc boards	motors -	solenoids
IC's	relays	connectors	lamps
switches	wire-fans	meters	hardware



## C & S SUPPLY

1469 Cuyamaca Street  
El Cajon, California

Hours: Mon.-Fri. 9:30 - 5:30  
Sat. 9:30 - 1:00  
closed Sundays

located 1 mile north  
of Fletcher Parkway

CALL US — TELEPHONE 448-5000

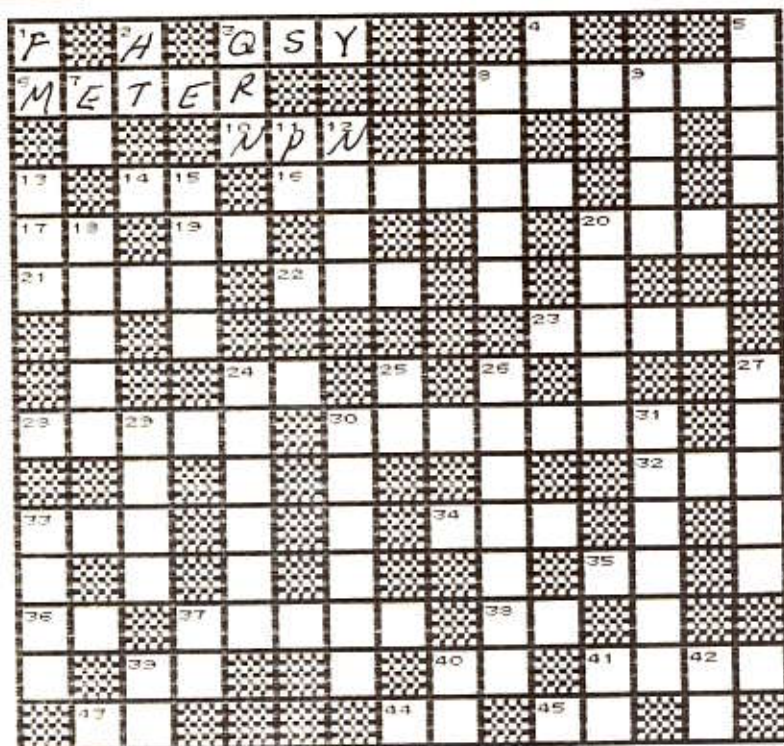

## ACROSS CLUES

3. I'M CHANGING FREQUENCY
6. INDICATING DEVICE
8. FULL-WAVE RECTIFIER
10. TRANSISTOR TYPE
14. SWITZERLAND
16. STATION ON-THE-GO
17. DODECANESE
19. BEFORE SSE
20. CONTROLLED BY THE GATE
21. FIXED NEGATIVE VOLTAGE
22. DIODE THAT EMITS LIGHT
23. TELEPRINTER ELEMENT
24. HOOR TUBE
28. RATE OF DOING WORK
30. DISCHARGES A CAPACITOR
32. MAY BE POS. OR NEG.
33. TO STOP SENDING
34. VOICE DEVICE
35. BOLIVIA
36. PRODUCES A SINEWAVE
37. FOR CONSTANT VOLTAGE
38. SPAIN
39. GERMANY
40. CLOSED REPEATER
41. FORMS A BATTERY
43. CIRCUIT ON A CHIP
44. CHINA
45. WALES

## DOWN CLUES

1. VHF MODULATION
2. HAND-HELD STATION
3. TROUBLED BY STATIC
4. END OF TRANSMISSION
5. DIRECTIONAL ANTENNA
7. LIBERIA
8. ANTENNA MATCHING DEVICE
9. ARRL AWARD
11. PHASE MODULATION
12. MINIMUM CURRENT
13. GAIN OF 9DB. OVER AM
15. TRANSISTOR ELEMENT
18. PRODUCT OF SSTV
20. TELEPRINTER ELEMENT
24. THREE ELEMENT TUBE
25. FEMALE AMATEUR
26. RELATIVE POWER UNIT
27. UNIT OF INDUCTANCE
29. MEASUREMENT OF POWER
30. ISOLATES TWO STAGES
31. PULSATIONS OF A RECTIFIER
33. HAS SQUARE ELEMENTS
37. NEW ZEALAND
39. CURRENT IN ONE DIRECTION
40. BRAZIL
41. TELEGRAPHY
42. ARGENTINA

Happy 50th  
Anniversary to  
Mary  
&

John "CARMEN" Sinatra

to love  
and cherish

happy\* anniversary

S A M

I love you, J H B J

ka 6 mly

## CAL'S CORNER

Hello again,

I have had the extraordinary good fortune to get my hands on a rare copy of V.P. Pettybone's first notebook, in which he recounts, among other things, a visit to San Diego in 1980. V.P. had pretty good ears! After the promise of a few 807's, SQUELCH TALES editor agreed to publish it in it's entirety!

*Cal*  
WD6

Drink  
Straight  
Vodka

### FROM V. P. PETTYBONE'S NOTEBOOK

During World War II Grampa Pettybone wrote about pilot mistakes and aircraft accidents in the Navy.

Grampa was somewhat of a cracker-barrel philosopher. His writing style was simple and to the point. He had a certain flare with the military jargon, and sprinkled in just enough slang to make the flavor a little salty.

Grampa liked to summarize formal Navy Aircraft Accident Reports which had all the legal terminology and engineering falderal to successfully put the blame somewhere between Monday and a dead cat. He added a little humor, simplified the report, and shortened it to one paragraph - - two paragraphs if the accident was a real whing-dinger, or if he considered the report to be a snow-job. Grampa's articles were published in a monthly magazine which was sanctioned by the Navy. The magazine was popular at Naval Air Stations, and on board Aircraft Carriers. There was a certain amount of suspense involved. One could never be sure, particularly if he had been caught in some gross infraction, or been involved in an aircraft accident, that he wouldn't be featured in Grampa Pettybone's next blistering account.

Not everyone agreed with Grampa, but that didn't bother him. He was a little too old and wobbly to fly high performance aircraft off the carriers, but his heart was in the cockpit with every young pilot. The bottom line for Grampa was to preserve human life, and to maintain safety in flying. If the quip from his pen felt like the sting of a lash, it was meant to be

just that for the pilots who had displayed certain unhealthy flying habits. Grampa believed that his efforts were all worth while if his comments prevented a single accident or preserved a single life.

Grampa welcomed rebuttals, and the magazine printed those which made a good point. Once he wrote, "The pilot who has enough smarts to get a hunk of iron in the air, and safely land it on the deck of a ship bobbing on the ocean, certainly has the ability to make up his own mind about a paragraph or two written by Grampa Pettybone." In any event, Grampa Pettybone never challenged a single rebuttal.

The grandson, V. P. Pettybone never knew his Grampa. VP was in the old house that afternoon, after his grandfather passed on, when everything in the attic went to the swap-meet. One of the things that was left behind to burn was a stack of magazines wrapped in sail cloth, and tied with an old piece of shot-line. VP confiscated the magazines. He planned to use them to add weight to the bundles of newspapers he regularly sold to the paper recycling outfit across town. One morning while carefully slipping them in between newspapers, one of the magazines fell to the floor, and by pure chance lay open at the page containing one of Grampa Pettybone's more scathing attacks on a young pilot who had accidentally(?) flown a PANTHER under Golden Gate Bridge. That was when VP first learned that his grampa fought WWII with a pen instead of a gun.

VP carefully searched through the old magazines. Sure enough, his grampa had a few lines in almost every one. Grampa was no Hemmingway. But VP enjoyed his grampa's wit and candid narrations. VP thought for a moment that it might be fun to get something in print himself, but then there was no longer a major war, and the PANTHER airplanes had all been melted down, and made into household cooking utensils. The idea faded, almost as quickly as....

VP traveled a lot. He took along his hand-held, and worked the local repeaters. It gave him somewhat of an insight as to what was going down, and made the evenings in the hotel rooms a little more enjoyable. Sometimes he even checked in on the

(Continued on Page 20)

(Continued from Page 19)

local net. In his younger years, before he discovered ham radio, he spent a lot of time in the hotel bars. The drunks, the noise, the waterfront vernacular, and the unnecessary degrading exchanges between customers eventually, drove him away.

VP had spent a number of years on the lower bands with the DXers and the ragchewers. He enjoyed those years. Unfortunately, the drunks, the noise, the waterfront vernacular, the people who distorted the intent of amateur radio by making their own rules ...and the fact that he traveled a lot, finally reduced his operating time on 40 meters to ZERO. But he still had fun on the two-meter repeaters.

While driving through Colby, Kansas one morning he heard a repeater on .34/.94 that claimed only three stations as members. They were glad to have another operator join them, and they invited him over for mid-morning coffee. VP still stops in Colby to see those guys when he goes through. Their group is bigger now. It has 3 operators, and one now-and-then-visitor.

V.P. Pettybone found the repeater environment a little different in Southern California. When he went through San Diego sometime back he noticed that one of the most popular repeaters was .04/.64. At that time the main topic discussed on that repeater was the fact that someone wanted the machine removed from the mountain top. VP wondered why there was such a fuss about getting it OFF the mountain, when that really seemed to be the best place for it. He asked, but never received a straight answer from anyone on .04/.64, so he jotted down a few lines in his note book, and decided he'd ask the boys in Colby, Kansas what they thought. He was pretty sure they'd give their spare coax to have a mountain ...or even a little hill on which to locate a repeater....

Whether by accident or by design, VP's notes eventually took on a little of Grampa Pettybone's motif. VP was not surprised to see patterns emerge in repeater activities around the country. Some similar. Some different. It wasn't long before he decided that there were only two main differences between open repeaters,

ONE WAS THE DEGREE OF SOPHISTICATION OF THE MACHINES. Some were simple receive-transmit devices, carrier controlled, with the antenna mounted on a water tank or a windmill, like the one in Colby. To turn it off, one merely walked over to the water tank, and pulled the plug from an outlet that had been installed for ...well, no one really knew ...it was just there, and it was hot, so they used it. Other repeaters had computer-controlled-links, "PI," down-tilt antennas, voice identifiers, etc. They cost a whale of a lot of money to install, ...and no little amount of attention to keep running. The design and installation of these machines seemed to be of interest to only a hand full of club members ...the dedicated types, who had the ability and the interest to keep them running. Strangely, most of those guys didn't talk much on the machines which they so carefully pampered.

Their needs seemed to be satisfied by the fact that they got the machine to the top of the mountain, and they kept it operating at some agreed upon level of reliability.

Repeaters were sometimes thrown together with obsolete commercial gear modified to work on ham frequencies. Such equipment was noted for intermittent and unreliable operation. For some operators THAT was the major challenge. For others it gave them something to complain about. Those who complained always talked about their fellow amateurs as "they" ...they can't keep this thing running, ...they think this repeater belongs to THEM, ...they won't listen to me when I tell them how to keep that repeater 100% operational. However, "THEY" were the only ones who ever made it to the mountain top with a tool box and a VOM.

According to VP, THE ONLY OTHER FACTOR WHICH AFFECTED AN OPEN REPEATER WAS THE NUMBER OF PEOPLE WHO HAD ACCESS TO THE MACHINE. The geographic location, the sex of the custodian, the weather, big city, little berg...it made very little difference. The variety of activity on the repeater was related only to the number of people who used it. The more operators there were, the greater diversity there was in the type and quality of activity on the repeater.

(Continued on Page 21)

(Continued from Page 20)

In the megalopolis along the West Coast VP lost interest in the two-meter repeaters. The drunks, the noise, the decay in good sportsmanship, the waterfront vernacular, the people who distorted the intent of ham radio by making their own rules ... When God gave man the ability to be obnoxious, VP often thought, He didn't make a mistake. It was just another way that God gave man to show his true character.

V.P. PETTYBONE'S NOTEBOOK! He enjoyed keeping it. It wasn't much of a masterpiece. It didn't take him long to decide that Grampa Pettybone's ability with the pen wasn't hereditary. VP's notes may never save lives, nor reduce the cost of airplane accidents, but maybe, just maybe, they would give the local operators a chance to laugh at themselves, to contemplate, or to cry, or to get mad. Like Grampa Pettybone's pilots, maybe the licensed operators would reevaluate their own operating practices, get an idea just how they appear, good or bad, pleasant or cantankerous, helpful or destructive, a worthy example or a pain in the ass to another operator.

One day the boys in Colby asked VP if they could copy a couple of his anecdotes and pass them on to the editor of the paper for an Amateur Club out there in the middle of Kansas. VP Obliged them, and they sent the notes on the club.

In a few days they had a surprise response from the club's editor: "Great stuff, boys, but we can't use it ... section 605 of the Communications Act of 1934, you know ..."

Certified to be original:

*V.P. Pettybone*  
V. P. Pettybone

Via AMATEUR RADIO NEWS

EDITOR'S NOTE Despite V.P.'s comments, things are looking up lately on our Mt. Gray 106/64 machine. Courtesy seems to be contagious. More and more folks are waiting for the courtesy tone. Long QSO's are shifting off to simplex frequencies. Less reference to unidentified signals and there is less incitement to "jamming". Political discussions are diminishing. Starting to sound more like ham radio.

449-1004



Cal Auto Electric  
PARTS AND SERVICE

WD6DSV  
CAL FLAGEMAN

9365 Starcrest Dr  
SANTEE, CA 92071

## RUMMAGE SALE AND RAFFLE

MONTEZUMA VALLEY VOLUNTEER  
FIRE DEPARTMENT

RANCHITA - S22 AT SKYWAY

SALE MAY 28 - 31

RAFFLE MAY 31 1 PM

- 20 Gauge Over-Under Shotgun
- Dust Buster
- AM-FM Cassette Recorder
- Fire Extinguisher
- Deluxe Chaise Lounge
- Exotic Bird & Cage
- Smoke Detector
- Local Arts & Crafts

Plus Many More Surprise Prizes

DONATION - \$1.00      Need No: Be Present To Win

MAKE CHECKS PAYABLE TO:  
M.V. VOL. FIRE DEPARTMENT

SEND TO: RITA COOK N6FSO  
STAR RT. 2  
RANCHITA,, CA 92066  
(I WILL SEND YOU A RECEIPT)

73'S (N6FSO, N6FUT, N6BLI,  
KA6RFU, N6BLM)

714-460-3610

WA6BJQ  
GLENN JENSEN  
Marketing Representative

**Radio Shack**  
COMPUTER CENTER

A Division of Tandy Corporation

5346 JACKSON DRIVE, LA MESA, CA 92041

## POTPOURRI

AMATEUR RADIO FIRST may have been achieved on February 2. At 1220 PM, N6FNB, Gary, on board a diving tender, relayed the voice of Roger, a commercial diver. Roger was engaged in removing barnacles from the hull of the submarine tender Sperry, in San Diego harbour, 35 feet below the surface. WD6FKF leaped into the conversation, "What does fishing look like down there?" Roger replied that the freshly removed shells attracted schools of fish. WD6FKF was last seen headed for Pt. Loma, fishing tackle in hand. Gary now hopes to extend this underwater ham radio communication to a coast to coast phone patch.

TECHNICAL COMMITTEE At the April Board meeting, our newly appointed Technical Committee Chairman, Tom, AJ6L, came up with a "Blue Ribbon" list of names for the SANDRA Technical Committee. They were approved unanimously. (See Board Minutes.) Feed your thoughts about our repeaters to Tom, 449-8782. He has the challenging task of coming up with a long and short range plan for applying our resources to repeater equipment.

DX Longest distance membership renewal this month came from Alex, KE6CK. His note was datelined Palmer Station, Antarctica. The envelope was postmarked "USCGC Glacier, (WACB-4)". Wonder how .04/.64 is making it down there?

QST TO SANDRA MEMBERS The opportunity for you to sharpen your skill as a Net Controller now exists for our two weekly nets. Any member interested should contact me. I am presently coordinating schedules for the Sunday night 146.04/.64 8:00 PM net, and the Wednesday night 147.75/1 7:10 PM net. I will provide roll calls and standard procedures. Contact me via the SANDRA P.O. Box or at 566-2092.

TNX 73 Jack KBWEN

RENEWING MEMBERSHIP? More folks all the time are now signing up for two or three years ahead. Saves the bother, and offsets potential inflation in up-coming membership rates.

BY-LAWS CHANGES As noted in the March Membership Meeting minutes elsewhere in this issue, a change to the By-Laws proposed last January was approved. This dealt with the number of offices in SANDRA that a single person could hold. To keep your By-Laws up to date, attach the January proposal.

MANY THANKS To Mike, WA6URR, who did the word processing for SQUELCH TALES for the last four issues. Mike's recent job change created a mutual logistics problem, and we reluctantly have parted company. Mike has a couple of ASDEN 2000's that he will part with at the right price. Call him at 426-7534. Thanks again.

<b>K2JD ENGRAVING</b>			Prompt Delivery
Send Orders To	1278 OLEANDER AVE CHULA VISTA, CA 92011 PH 714-421-1892		
Cash Or Check. Sorry No COD			For Hams. By Hams.
<b>CALL SIGN BADGES</b>			<b>CAPS</b>
<b>Size • Up to</b>		<b>Cost</b>	
3/4 x 3 (1 line)		\$1.25	COLORS: BLUE KELLY GREEN RED GOLD  MAXIMUM 2 LINES 6 LETTERS PER LINE  
1 1/4 x 3 (2 line)		\$2.00	
2 x 3 (3 line)		\$2.25	
2 x 4 (4 line)		\$2.75	
Most color badges are in stock	STAMPS BADGES POSTPAID	ARRL sig on stamp or badge add 50¢	
<b>RUBBER STAMPS</b>			
ADDRESS STAMP OR CALL SIGN & QTH			
3 LINES \$2.50 EXTRA LINE 50¢			
			<b>\$5.00 plus \$1.00 SHIPPING</b> ARRL sig on cap 50¢ extra



## LADIES NITE

The Saturday nite 2 meter T hunt in San Diego is gaining in interest. The airplane/fixed station rabbits we reported on in December SQUELCH TALES was a classic. However, we now must report the first annual ladies night, when the gals stumped the best in the West.

Third Saturday of the month is the big event, when the pros roar off Crystallaire Drive atop Del Cerro Heights to prove their mettle. March 20 there were at least twenty vehicles at the start. Carole, N6FUY; Peggy, WB6OZC; and Barbie, WA6URS were the bait.

TWO HOURS later, the first hunters arrived on the picnic scene. The girls had selected easy to reach Balboa Park, had the party table all set up, and had Carole and her brother Jeff pushing the hidden T around the Park Museum, Zoo, Del Prado, and Old Globe areas in a baby buggy! Geneve transmitter, signal generator, gel cell batteries, mag-mount antenna on a pie pan, cuddly blankets, teddy bear, and the whole works. Blonde Carole wore red wig, and some unmentionable clothes. No way to drive a car into this area of the park, so the pros were reduced to

hand holds and sniffers. Many passed within feet of the simulated man and wife without tumbling!

The word is that some of our pros have gone back to the drawing board.



• From left to right: Peggy, WB6OZC Jeff, the simulated husband; Carole, N6FUY, simulated mommy; and Barbie, WA6URS.

3750 Sports Arena Blvd.  
San Diego, CA 92110

**224-2107**



Located in  
Sports Arena Village  
Shopping Center

**SUPERB MEXICAN FOOD  
& COCKTAILS**

**AT REASONABLE PRICES**

**LUNCH & DINNER - FOOD TO GO**



JIM BURTON N6EYR

# WGSZX

# ELECTRONIC

# SWAP

# MEET

## 7-AM

FIRST SATURDAY

OF EACH MONTH at SANTEE DRIVE-IN



COME IN FOR BREAKFAST BEFORE THE SWAP MEET  
WE OPEN AT 5:00 A.M.

**COUPON**

**SANTEE GRILL**  
& FAMILY RESTAURANT  
9569 MISSION GORGE, SANTEE

**HAM RADIO SPECIAL!**

COUNTRY SAUSAGE, EGGS, &  
BISCUITS W/COUNTRY GRAVY  
FOR \$1.99

**DISCOUNT**

**OFFICERS:**

President  
 W6UZL WALT HICKS 292-7918  
 Vice-President  
 WA6AIL LARRY COX 277-6352  
 Secretary  
 W6OGC JIM ALLEN 579-7951  
 Treasurer  
 WA6OYI DENNIS ROMACK 274-0277  
 Membership  
 W6GIC SYBIL ALLBRIGHT 278-4284  
 Meetings  
 WB6IKF JIM FRANKLIN 726-4022  
 Past President  
 WA6JTB JOHN NABORS 475-2150  
 M.A.L. Three Year  
 W6PDA WAYNE BAMFORD 277-8320  
 M.A.L. Two Year  
 K8WEN JACK CARLSON 566-2092  
 M.A.L. One Year  
 WA6QVW LES NUHN 277-3903

**TRUSTEES:**

MT OTAY WA6YVX ED FLINN  
 MT LAGUNA W6PDA WAYNE BAMFORD  
 LYON'S PEAK W6SS VANCE BELLISTON  
 SHARP HOSPITAL K6QL DAVE FENDER  
 AUTOPATCH CODE: 82\* UP, 82# DOWN

**SQUELCH TALES**

SQUELCH TALES is published monthly by the San Diego Repeater Association (SANDRA, Inc.), a non-profit corporation dedicated to the promotion of Amateur Radio. Distribution is free to members of the organization; subscriptions are available to others. News, views, and information exchanges (particularly newsletter exchanges with other clubs) are desired and solicited. The right to edit material submitted with respect to format, suitability, and style is reserved. Decisions are final.

Advertisements are \$30 per page, \$19 per half page, and \$7.50 for a quarter page of business card ad. Artwork or layouts should be submitted to reach the Editor by the first of the month in which the ad is to appear. Assistance in preparation of artwork and layout is available at no charge to advertisers desiring this service, although a longer lead time is necessary. Contact the Editor for specific requirements. Advertisements prepared by the SQUELCH TALES staff remain the property of SQUELCH TALES and may not be used elsewhere without written permission. Liability for errors in copy or other matter is limited to the printing of a correction in the subsequent issue.

Permission is hereby granted to reprint items from this issue of SQUELCH TALES in other Amateur Radio oriented publications provided credit is given to SQUELCH TALES and when appearing the author. Articles are only accepted on this condition unless otherwise noted. No liability is assumed for accuracy or originality of material. Opinions expressed, unless specifically noted, are not necessarily the position of the organization. Editorial Staff or Board of Directors of SANDRA, Inc.

STAFF: WALT HICKS EDITOR W6UZL 292-7918  
 SYBIL ALLBRIGHT W6GIC 278-4284  
 DON DRAKE WA6IPW 692-1126  
 INFORMATION & INTERFERENCE: 277-3903

\* FREE \*

GOOD AT REGULAR DRAWING

APRIL  
 MEETING  
 EXCHANGE AT DOOR



**SANDRA OPERATES TWO NETS:**

Sunday Evening at 8:00 p.m. on 04/64  
 Wednesday Eve. at 7:30 p.m. on 75/15

SANDRA, Inc. operates the following repeaters for service to the San Diego area and environs. The policy of the organization is that the repeaters are available for all licensed Amateurs to use, so long as applicable rules and regulations are observed, whether members of SANDRA, Inc. or not. Further, the following priorities must be observed: (1) Emergency traffic, concerning the safety of life or property take priority over all other traffic. Failure to yield to any station indicating the need for such traffic is prohibited, and may render the offender subject to legal action. Indication of the need for such traffic may be "Break Emergency," "Break-Break," or any other clearly indicated statement. (2) Call-ups should be permitted. If an operator "breaks" into a conversation, he should be permitted to make such a callup. He should not, however, "take over" the repeater and exclude those who were already using it. (3) "Rag-chewing" is not prohibited, but care must be exercised to assure that the repeater is not tied up for extended periods. Remember, there are almost 900 members, and several hundred non-members, who have as much right to use the facilities as you do. It is extremely discourteous to monopolize them to the exclusion of these other users. Long CSOs should be limited to simplex frequencies or the lower bands.

K6QL	SHARP HOSPITAL	147.285	147.885
	(AUTOPATCH REPEATER)		
WB6WLV	MT OTAY	146.04	146.64
WB6WLV	MT OTAY	222.60	224.20
WB6WLV	MT OTAY	*444.50	449.50
W6PDA	MT LAGUNA	147.75	147.15
W6PDA	MT LAGUNA	222.46	224.06
W6PDA	MT LAGUNA	*444.825	449.825
W6SS	LYON'S PEAK	146.865	146.265

\*1-B PL REED



Yes, I would like to become a member of SANDRA.

Full Membership: \$10 MEMBERSHIP  
 \$10 INITIATION (ONE TIME)  
 \$20 TOTAL

Limited Membership: \$12 PER YEAR

(Only for those who live outside of the San Diego area. Voting privileges are not included.)

Amount Enclosed \$ \_\_\_\_\_ Date \_\_\_\_\_ Signature \_\_\_\_\_

NAME \_\_\_\_\_ CALL \_\_\_\_\_

ADDRESS \_\_\_\_\_ PHONE \_\_\_\_\_

CITY \_\_\_\_\_ STATE \_\_\_\_\_ ZIP \_\_\_\_\_

Mail to SANDRA, Inc., Post Office Box 81103 San Diego, Ca., 92138

SANDRA, Inc.

SAN DIEGO REPEATER ASSOCIATION  
POST OFFICE BOX 81103  
SAN DIEGO, CA 92138

INFORMATION AND INTERFERENCE PHONE  
NUMBER (714) 277-3903

## Calendar Of Events

- APRIL 15 MEMBERSHIP MEETING, DEPARTMENT OF  
EDUCATION, 6401 LINDA VISTA ROAD.  
BOB RUBESH, ROBOT RESEARCH, WILL  
TALK AND DEMONSTRATE AMATEUR TV. 7:30 PM
- APRIL 17 REGULAR T-HUNT NITE. STARTS ON  
CRYSTALAIR DRIVE, DEL CERRO HEIGHTS.  
8:00 PM
- APRIL 22 SANDARC MEETING. BONANZA RESTURANT.  
8105 CLAIREMONT MESA BLVD. 7:30 PM
- MAY 1 ELECTRONICS SWAP MEET AT SANTEE DRIVE  
IN THEATER. 7:00 AM
- MAY 6 SANDRA BOARD OF DIRECTORS MEETING AT  
THE BONANZA RESTURANT, 2633 EL CAJON  
BLVD. ALL SANDRA MEMBERS WELCOME.  
7:30 PM

BULK RATE  
U.S. POSTAGE  
PAID  
Permit No. 1520  
San Diego, Calif

DATED MATERIAL

Address Correction Requested

APRIL MEMBER CHECK LIFE  OR ANNUAL

TO RENEW, CLIP AND MAIL WITH YEARLY DUES  
\$10 FULL MEMBERSHIP  
\$12 LIMITED MEMBERSHIP  
TO: SANDRA INC.  
P.O. BOX 81103  
SAN DIEGO CA 92138

SHOW CORRECTIONS, IF ANY, FOR LABEL &/OR ROSTER